

Bitssats Mix



10st bits, bitshållare med magnet.

Art.nr	Bits	Storlek
BT860	LP	0,5x3 mm
BT860	LP	1x5,5 mm
BT860	LP	1,2x6,5 mm
BT860	PH	1, 2, 3
BT860	PZ	1, 2, 3
BT882M1	Bitsh.	1/4"

BT860MIXA10

Bitssats Torx



10st bits, bitshållare med magnet.

Art.nr	Bits	Storlek
BT860 T		7, 8, 9, 10, 15, 20, 25, 27, 30, 40
BT882M1	Bitsh.	1/4"

BT860TXA10

Bitssats Ribe



22st delar

30mm & 75mm

Bits: M4, M5, M6, M7, M8, M9, M10, M12, M13, M14

Bitshållare: 3/8" 1/2"

JESX105

Bitssats



○	867PE	4-5-6-7-8-10-12 mm
○	867PE/L	4-5-6-7-8-10-12 mm
○	867XZN	M5-M6-M8-M10-M12
○	867XZN/L	M5-M6-M8-M10-M12
⊕	867TX	T20-T25-T30-T40-T45-T50-T55
⊕	867TX/L	T20-T25-T30-T40-T45-T50-T55
⊕	867RTX	T20-T25-T30-T40-T45-T50-T55
⊕	867RTX/L	T20-T25-T30-T40-T45-T50-T55
	867/1	⊕10 mm - □3/8"
	867/2	⊕10 mm - □1/2"

BT867C52

Förlängningsadaptör Med kula



Art.nr	Ansl.	Ansl.	Längd
KT11050B	1/4"	1/4"	50 mm
KT11250B	3/8"	1/4"	50 mm
KT13560B	1/2"	1/4"	60 mm

Bitshylsa Insex 1/4"



Bitshyllsa med magnet. Längd 65mm

Art.nr Storlek i mm

BT862F55	5,5
BT862F6	6
BT862F7	7
BT862F8	8
BT862F10	10
BT862F12	12
BT862F13	13

Bitshållare



Art.nr	Ansl.	Bits
BT8951	1/4"	1/4"
BT8953	3/8"	1/4"
BT8954	3/8"	5/16"
BT8955	1/2"	1/4"
BT8956	1/2"	5/16"
BT8671	3/8"	10 mm
BT8672	1/2"	10 mm

Bitshållare Med magnet



1/4" x 1/4"
Längd 75 mm

BT882M1

Bitshållare Spärnnyckel



För 1/4" & 5/162 bits

Längd 128 mm

BT194

Flexmejsel För bits 1/4"



L: 280 mm

L1: 154 mm

BT897



L: 500 mm

L1: 380 mm

BT897L

Bitsmejsel 1/4" Med magnet



För 1/4" bits

Art.nr	Längd	L1
BT8511	165 mm	45 mm
BT8512	245 mm	125 mm

Bits 1/4" Lång



Art.nr.	Dim./mm
BT862LP1	0,5x3
BT862LP2	0,6x4,5
BT862LP3	0,8x5,5
BT862LP4	1x5,5
BT862LP5	1,2x6,5
BT862LP6	1,2x8
BT862LP7	1,6x8

Bits 1/4" +



Art.nr	Dim.
BT861PZ1	1
BT861PZ2	2
BT861PZ2L	2L
BT861PZ3	3
BT861PZ4	4

Bitsmejsel 1/4" Spärr



För 1/4" bits

Art.nr	Längd	L1
BT855	187 mm	62 mm

Bits 1/4" +



Art.nr.	Dim.
BT861PH0	0
BT861PH1	1
BT861PH2	2
BT861PH2L	2L
BT861PH3	3
BT861PH4	4

Bits 1/4" +

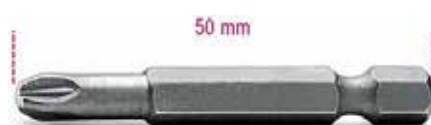

Art.nr.	Dim.
BT862PZ1	1
BT862PZ2	2
BT862PZ3	3

Bitsmejsel Vändbar



Art.nr.	Bits	Dim.
MLSDR1	LP	3x1 mm
	LP	5,5x1,2 mm
	PH	1
MLSDR3	PH	2
	T	10
	T	15
	T	20
	T	25

Bits 1/4" +



Art.nr.	Dim
BT862PH1	1
BT862PH2	2
BT862PH3	3

Bits 5/16" +



Art.nr.	Dim.
BT866PZ1	1
BT866PZ2	2
BT866PZ3	3
BT866PZ4	4

Bits 1/4" ●



Art.nr.	Dim./mm
BT861LP1	0,5x3
BT861LP2	0,6x4,5
BT861LP3	0,8x5,5
BT861LP4	1x5,5
BT861LP5	1,2x6,5
BT861LP6	1,2x8
BT861LP7	1,6x8

Bits 5/16" +



Art.nr.	Dim	L mm
BT866PH1	1	32
BT866PH2	2	32
BT866PH3	3	32
BT866PH4	4	38

Bits 5/16" ○



Art.nr.	Dim./mm
BT866PE3	3
BT866PE4	4
BT866PE5	5
BT866PE6	6
BT866PE8	8
BT866PE10	10

Bits 10mm 

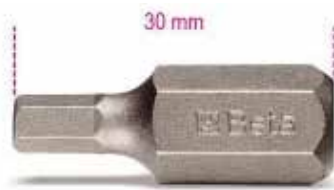

Art.nr.	Dim
BT867PE4	4
BT867PE5	5
BT867PE6	6
BT867PE7	7
BT867PE8	8
BT867PE10	10
BT867PE12	12

Bits Ribe 10mm 



Art.nr.	Dim
JESX1054	4
JESX1055	5
JESX1056	6
JESX1057	7
JESX1058	8
JESX1059	9
JESX10510	10
JESX10512	12
JESX10513	13
JESX10514	14

Bits Torx med hål 1/4" 



Art.nr.	Dim.
BT861RTX9	T9
BT861RTX10	T10
BT861RTX15	T15
BT861RTX20	T20
BT861RTX25	T25
BT861RTX27	T27
BT861RTX30	T30
BT861RTX40	T40

Bits 10mm 



Art.nr.	Dim./mm
BT867PE4L	4
BT867PE5L	5
BT867PE6L	6
BT867PE7L	7
BT867PE8L	8
BT867PE10L	10
BT867PE12L	12

Bits Ribe 10mm 



Art.nr.	Dim
JESX1056	6
JESX1057	7
JESX1058	8
JESX1059	9
JESX10510	10
JESX10512	12
JESX10514	14

Bits Torx 5/16" 



Art.nr.	Dim.
BT866TX20	T20
BT866TX25	T25
BT866TX27	T27
BT866TX30	T30
BT866TX40	T40
BT866TX45	T45
BT866TX50	T50
BT866TX55	T55

Bits Insex 1/4" 



Art.nr.	Dim./mm
BT862PE3	3
BT862PE4	4
BT862PE5	5
BT862PE6	6
BT862PE8	7

Bits Torx 1/4" 



Art.nr.	Dim.
BT861TX6	T6
BT861TX7	T7
BT861TX8	T8
BT861TX9	T9
BT861TX10	T10
BT861TX15	T15
BT861TX20	T20
BT861TX25	T25
BT861TX27	T27
BT861TX30	T30
BT861TX40	T40

Bits Torx 10mm 



Art.nr.	Dim.
BT867TX20	T20
BT867TX25	T25
BT867TX30	T30
BT867TX40	T40
BT867TX45	T45
BT867TX50	T50
BT867TX55	T55

Bits 1/4" 



Art.nr.	Dim/mm
BT861PE2	2
BT861PE25	2,5
BT861PE3	3
BT861PE4	4
BT861PE5	5
BT861PE6	6
BT861PE8	8
BT861PE10	10

Bits Torx 10mm 



Art.nr.	Dim.
BT867TX20L	T20
BT867TX25L	T25
BT867TX30L	T30
BT867TX40L	T40
BT867TX45L	T45
BT867TX50L	T50
BT867TX55L	T55

Bits Torx med hål 10mm 

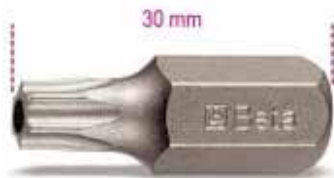

Art.nr.	Dim.
BT867RTX20	T20
BT867RTX25	T25
BT867RTX30	T30
BT867RTX40	T40
BT867RTX45	T45
BT867RTX50	T50
BT867RTX55	T55

Spärnyckel 13x500mm



SW58510000

Bits Insextapp  Anslutning 13mm



Art.nr.	Ø mm
SW57502040	4
SW57502060	6
SW57502070	7
SW57502080	8
SW57502100	10

Bits Torx med hål 10mm 



Art.nr.	Dim.
BT867RTX20L	T20
BT867RTX25L	T25
BT867RTX30L	T30
BT867RTX40L	T40
BT867RTX45L	T45
BT867RTX50L	T50
BT867RTX55L	T55

Bitssats Kort



SW58511000

Bitssats Specialkorta med spärr



Innehållande
 Torx 15,20,25,27,30,40,45,50,55
 XZN 4,5,6,8,10
 6-Kant 4,5,6,7,8,10
 Adapter 1/4" & 3/8"
 samt 2st olika ledspärnycklar
MU514600

Bits XZN 10mm 



Art.nr.	Dim.
BT867XZN	M5
BT867XZN	M6
BT867XZN	M8
BT867XZN	M10
BT867XZN	M12

Hylsa Kort  Anslutning 13mm



Art.nr.	Ø mm
SW58500070	7
SW58500080	8
SW58500090	9
SW58500100	10
SW58500110	11
SW58500120	12
SW58500130	13
SW58500140	14

Bits XZN 10mm 

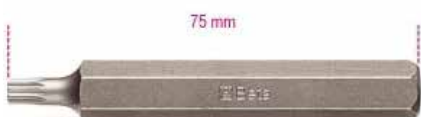

Art.nr.	Dim.
BT867XZN	M5
BT867XZN	M6
BT867XZN	M8
BT867XZN	M10
BT867XZN	M12

Bits T15-55  Anslutning 13mm



Art.nr.	Ø
SW57500150	T15
SW57500200	T20
SW57500250	T25
SW57500270	T27
SW57500300	T30
SW57500400	T40
SW57500450	T45
SW57500500	T50
SW57500550	T55



Hålsåg



Art.nr. Ø mm

BT45014	14
BT45016	16
BT45017	17
BT45019	19
BT45020	20
BT45021	21
BT45022	22
BT45024	24
BT45025	25
BT45027	27
BT45029	29
BT45030	30
BT45032	32
BT45033	33
BT45035	35
BT45037	37
BT45038	38
BT45040	40
BT45041	41
BT45043	43
BT45044	44
BT45046	46
BT45048	48
BT45051	51
BT45052	52
BT45054	54
BT45057	57
BT45059	59
BT45060	60
BT45064	64
BT45065	65
BT45067	67
BT45068	68
BT45070	70
BT45073	73
BT45076	76
BT45079	79
BT45083	83
BT45086	86
BT45089	89
BT45095	95
BT450102	102
BT450105	105
BT450108	108
BT450111	111
BT450121	121
BT450127	127
BT450140	140
BT450152	152

Hålsågsats 19-64mm



13st delar
22, 29, 35, 38, 44, 51, 57, 64 mm
2 st hållare

BT450C13

Hålsågsats 22-64mm



9st delar
22, 29, 35, 44, 51, 64 mm
2 st hållare

BT450C9

Hålsågsfäste 14-30mm



BT450AL1

Hålsågsfäste 32-152mm



BT450AL2

Cemtrumborr Till BT450AL



Cemtrumborr till BT450AL1

BT450PA1

Cemtrumborr till BT450AL2

BT450PA2

Hålsågsförlängare



Art.nr. L mm

BT450PR300

305

Hålsåg



Art.nr. Ø mm

BT45112	12
BT45113	13
BT45114	14
BT45115	15
BT45116	16
BT45117	17
BT45118	18
BT45119	19
BT45120	20
BT45121	21
BT45122	22
BT45123	23
BT45124	24
BT45125	25
BT45126	26
BT45130	30
BT45132	32
BT45135	35
BT45140	40
BT45150	50

Punktsvetsfräs 10mm



Fjäderbelastad mittpunkt hjälper till att föra kronan på plats för punktsvetsen.
Finjustering av djup med skruv.
Lämplig för luft och bormaskiner.

JEZ1

Punktsvetsskär 2st



JEZ1C2

Borr HSS 8% Cobolt



Art.nr.	Ø mm	Längd
BT415150	1,5	40
BT415200	2	49
BT415250	2,5	57
BT415300	3	61
BT415350	3,5	70
BT415400	4	75
BT415450	4,5	80
BT415500	5	86
BT415550	5,5	93
BT415600	6	93
BT415650	6,5	101
BT415700	7	109
BT415750	7,5	109
BT415800	8	117
BT415850	8,5	117
BT415900	9	125
BT415950	9,5	125
BT4151000	10	133
BT4151050	10,5	133
BT4151100	11	142
BT4151150	11,5	142
BT4151200	12	151
BT4151250	12,5	151
BT4151300	13	151

Borrkasset HSS Ø1-13 x 0,5mm



BT410SP25

Borr HSS



Art.nr.	Ø mm	Längd
BT410050	0,5	22
BT410100	1	34
BT410150	1,5	40
BT410200	2	49
BT410250	2,5	57
BT410300	3	61
BT410350	3,5	70
BT410400	4	75
BT410450	4,5	80
BT410500	5	86
BT410550	5,5	93
BT410600	6	93
BT410650	6,5	101
BT410700	7	109
BT410750	7,5	109
BT410800	8	117
BT410850	8,5	117
BT410900	9	125
BT410950	9,5	125
BT4101000	10	133
BT4101050	10,5	133
BT4101100	11	142
BT4101150	11,5	142
BT4101200	12	151
BT4101250	12,5	151
BT4101300	13	151
BT4101400	14	160
BT4101500	15	169
BT4101600	16	178
BT4101700	17	186
BT4101800	18	194
BT4101900	19	202
BT4102000	20	210

Punktsvetsborr HSS



Art.nr.	Ø mm	Längd mm
BT423A1	6.5mm	40mm
BT423A2	8.0mm	40mm

Borrkasset HSS Ø1-10 x 0,5mm



BT410SEL19

Punktsvetsborr HSS



Art.nr.	Ø mm	L mm
BT4236MM	6	66
BT4237MM	7	74
BT4238MM	8	79
BT42310MM	10	89

Borrkaset HSS Ø1-10 x 0,5mm



BT410SP19

Hålborr Konisk HSS



Art.nr.	Ø mm	L mm
BT4243	16-30	60
BT4245	3-31	102

Stegborr HSS



Art.nr.	Ø mm	L mm	S mm
BT4251	4-12	70	1
BT4253	4-20	85	2
BT4256	4-30	75	2

Brytspett Vinkel 30°



Art.nr.	B mm	L mm
ML7025	19	400
ML7026	23	500
ML7027	25	610
ML7028	25,5	770

Brytjärn



Art.nr.	L mm
MU276503	390
MU276504	620
MU276505	880

Stegborrsats Konisk



Art.nr.	Ø mm	L mm
BT4241	3-14	58
BT4242	6-20	63
BT4243	16-30	60
BT424SP3		

Brytspett Vinkel 90°



Art.nr.	B mm	L mm
ML7031	15,5	410
ML7032	19	455

Brytspettsats 4st



16mm Chrome Molybden stål
 900mm rak
 900mm 45°
 600mm 75°
 600mm 90°
JEAK9100

Stegborrsats



Art.nr.	Ø mm	L mm	S mm
BT4251	4-12	70	1
BT4253	4-20	85	2
BT4256	4-30	75	2
BT425SP3			

Brytjärn



Art.nr.	L mm	L1	A
BT965300	300		
BT965400	450		
BT965600	600		

Brytjärn



Tvåhandsbrytspett med 45° vinklat huvud.
 Totalängd 1130 mm
MU276342

Brytspett 400mm



E166

Brytjärn



Art.nr.	L mm
MU276501	240
MU276502	320
MU276503	390



Bokstavsstansar



För märkning i stål, 27 bokstäver, A-Z leveras i en plastförvaringsbox.

Art.nr.	Ø mm
E400B3	3
E400B4	4
E400B5	5
E400B6	6
E400B7	7
E400B8	8
E400B10	10

Sifferstansar



För märkning i stål 0-9, leveras i en plastförvaringsbox.

Art.nr.	Ø mm
E400Z3	3
E400Z4	4
E400Z5	5
E400Z6	6
E400Z7	7
E400Z8	8
E400Z10	10

Körnare



Art.nr.	Ø mm	L mm
BT323	3	100
BT324	4	125
BT325	5	150

Automatkörnare



Art.nr.	Ø mm	L mm
BT32AU	3	150

Dorn



Art.nr.	Ø mm	L mm
BT302	2	125
BT303	3	125
BT305	5	150
BT306	6	150

Dorn



Art.nr.	Ø mm	L mm	L1 mm
BT312	2	110	22
BT313	3	128	35
BT314	4	146	45
BT315	5	164	55
BT316	6	182	65
BT318	8	200	80
BT3110	10	220	95

Dorn



Art.nr.	Ø mm	L1 mm	L mm
BT31L4	4	80	175
BT31L5	5	80	175
BT31L6	6	80	175

Dorn Med styrtapp



Art.nr.	Ø	D	L	L1
BT31SE4	4	2,4	175	80
BT31SE5	5	3,0	175	80
BT31SE6	6	3,6	175	80

Dorn med skyddshantag



Stötdämpning, säkert handtag & handskydd.

Art.nr.	Ø mm	L mm	L1 mm
BT31BM2	2	168	42
BT31BM3	3	180	52
BT31BM4	4	191	62
BT31BM5	5	200	72
BT31BM6	6	221	82
BT31BM8	8	235	94

Dorn Koniskt



Art.nr.	Ø mm	L1 mm	L mm
ML4612	6-12,5	115	350
ML4818B	12,7-22	165	455

Mässingsdorn



Art.nr.	Ø mm	L mm
MU841001	20	300

Dornsats Körnare 6st



Art.nr.	Ø mm
BT31	2-3-4-5-6-8
BT31B6	

Huggmejsel Med handtag



Art.nr.	L mm	L1 mm
BT1342PM	235	118

Skyddshandtag Huggmejsel



Art.nr.	Till uggmejsel
BT35PMR200	BT35200
BT35PMR250	BT35250
BT35PMR300	BT35300

Dornsats Körnare 6st



Art.nr.	Ø mm	L mm	L1
BT3L	4-5-6	175	80
BT31SE	4-5-6	175	80

Huggmejsel Räfflad



Art.nr.	L mm	A mm
BT35100	100	14,5
BT35125	125	17
BT35150	150	20,5
BT35200	200	23
BT35250	250	28,5
BT35300	300	34

Hålpipa



Art.nr.	Ø mm	L mm
E2861	1	105
E2862	2	105
E2863	3	105
E2864	4	110
E2865	5	115
E2866	6	115
E2867	7	120
E2868	8	120
E2869	9	125
E28610	10	125
E28611	11	125
E28612	12	130
E28613	13	130
E28614	14	135
E28615	15	135
E28616	16	140
E28617	17	140
E28618	18	150
E28619	19	150
E28620	20	155
E28621	21	155
E28622	22	155
E28623	23	155
E28624	24	160
E28625	25	160

Dornsats



Ett tåligt verktyg för kraftfull och exakt effekt.
Stötdämpande förmåga
Säker hand
Handskydd
BT31BMD6

Huggmejsel

Extra platt mejsel med rak kniv.



Art.nr.	L mm	A mm
BT1342	235	26

Dornsats Lång



Art.nr.	Ø mm	L mm	L1 mm
	3-4-5-6	200	9,5
	8-10	200	12
JEAK9128L			

Skyddshandtag Huggmejsel



Till huggmejsel BT1342PM
BT1342PMR





Blocknyckelsats



Art.nr. Ø mm
BT42SC9I 8-10-11-12-13-14-15-17-19



Blocknyckel



Art.nr.	Ø mm	L mm
BT4255	5,5	95
BT426	6	95
BT427	7	105
BT428	8	116
BT429	9	127
BT4210	10	137
BT4211	11	148
BT4212	12	158
BT4213	13	169
BT4214	14	180
BT4215	15	190
BT4216	16	201
BT4217	17	212
BT4218	18	222
BT4219	19	233
BT4220	20	243
BT4221	21	254
BT4222	22	264
BT4223	23	275
BT4224	24	285
BT4225	25	296
BT4226	26	307
BT4227	27	317
BT4228	28	328
BT4229	29	338
BT4230	30	349
BT4232	32	370
BT4234	34	391
BT4235	35	412
BT4236	36	412
BT4238	38	433
BT4241	41	465

Blocknyckel

Blankpolerad



Art.nr.	Ø mm	L mm
BT42MP6	6	95
BT42MP7	7	105
BT42MP8	8	116
BT42MP9	9	127
BT42MP10	10	137
BT42MP11	11	148
BT42MP12	12	158
BT42MP13	13	169
BT42MP14	14	180
BT42MP15	15	190
BT42MP16	16	201
BT42MP17	17	212
BT42MP18	18	222
BT42MP19	19	233
BT42MP20	20	243
BT42MP21	21	254
BT42MP22	22	264
BT42MP24	24	285
BT42MP27	27	317
BT42MP30	30	349
BT42MP32	32	370

Blocknyckel i tum



Art.nr	Ø tum	L mm
BT42AS14	1/4 x 1/4	95
BT42AS516	5/16 x 5/16	116
BT42AS38	3/8 x 3/8	137
BT42AS716	7/16 x 7/16	148
BT42AS12	1/2 x 1/2	169
BT42AS916	9/16 x 9/16	180
BT42AS58	5/8 x 5/8	201
BT42AS1116	11/16 x 11/16	212
BT42AS34	3/4 x 3/4	233
BT42AS1316	13/16 x 13/16	254
BT42AS78	7/8 x 7/8	264
BT42AS1516	15/16 x 15/16	285
BT42AS1	1 x 1	296
BT42AS116	1.1/16 x 1.1/16	317
BT42AS118	1.1/8 x 1.1/8	338
BT42AS114	1.1/4 x 1.1/4	370
BT42AS151	1.5/16 x 1.5/16	391
BT42AS138	1.3/8 x 1.3/8	412
BT42AS1716	1.7/16 x 1.7/16	412
BT42AS112	1.1/2 x 1.1/2	433

Blocknyckel



Art.nr.	Ø mm	L mm
BT4546	46	520
BT4550	50	560
BT4555	55	610
BT4560	60	660
BT4565	65	710
BT4570	70	760
BT4575	75	810
BT4580	80	860

Blocknyckel Lång



Art.nr.	Ø mm	L mm
JEAK631010	10	189
JEAK631011	11	207
JEAK631012	12	225
JEAK631013	13	243
JEAK631014	14	261
JEAK631015	15	279
JEAK631016	16	297
JEAK631017	17	314
JEAK631018	18	333
JEAK631019	19	349

Blocknyckelsats Lång 10st



Art.nr.	Ø mm
	10-11-12-13-14-15-16-17-18-19

JEAK6310

Ringnyckel Lång



Art.nr.	Ø mm	L mm
JEAK631101	8x10	235
JEAK631102	11x13	328
JEAK631103	12x14	328
JEAK631104	13x15	368
JEAK631105	16x18	407
JEAK631106	17x19	407
JEAK6311	Helsats	

Ringspärnnyckel



Art.nr.	Ø mm	L mm
JEAK631908	08	222
JEAK631909	09	227
JEAK631910	10	242
JEAK631911	11	252
JEAK631912	12	268
JEAK631913	13	286
JEAK631914	14	306
JEAK631915	15	324
JEAK631916	16	349
JEAK631917	17	374
JEAK631918	18	385
JEAK631919	19	397
JEAK6319	Hel sats	

Ringspärnnyckel



Art.nr.	Ø mm	L mm
BT1426	6	136
BT1427	7	136
BT1428	8	136
BT1429	9	143
BT14210	10	159
BT14211	11	168
BT14212	12	174
BT14213	13	180
BT14214	14	190
BT14215	15	200
BT14216	16	216
BT14217	17	233
BT14218	18	239
BT14219	19	248
BT14222	22	285
BT14224	24	325
BT14227	27	355
BT14230	30	420
BT14232	32	420

Slagnyckel



Finns i storlekarna 27mm till 230mm.
Längd 180mm till 800mm.

BT58

Ringspärnnyckelsats



Art.nr.	Ø mm
BT142SC9I	10-11-12-13-14-15-17-19

Slagnyckel



Finns i storlekarna 24mm till 230mm.
Längd 162mm till 740mm.

BT78

Ringspärnnyckel i tum



Art.nr	Ø tum	L mm
BT142AS	5/16 x 5/16	136
BT142AS	3/8 x 3/8	159
BT142AS	7/16 x 7/16	168
BT142AS	1/2 x 1/2	180
BT142AS	9/16 x 9/16	190
BT142AS	5/8 x 5/8	216
BT142AS	11/16 x 11/16	233
BT142AS	3/4 x 3/4	248

Ringspärrnyckel Ledad



Art.nr.	Ø mm	L mm
BT142SN7	7	136
BT142SN8	8	136
BT142SN9	9	143
BT142SN10	10	160
BT142SN11	11	168
BT142SN12	12	174
BT142SN13	13	180
BT142SN14	14	193
BT142SN15	15	200
BT142SN16	16	216
BT142SN17	17	233
BT142SN18	18	239
BT142SN19	19	250
BT142SN22	22	285
BT142SN24	24	325

Förlängningsnyckel



Art.nr.	Max Ø mm	L mm
MU745100	26	340
Extra kraftig MU745102	46	580

Ringnyckel Torx



Art.nr.	Ø	L mm
BT95FTX68	E6xE8	115
BT95FTX1012	E10XE12	143
BT95FTX1418	E14XE18	177
BT95FTX2024	E20XE24	224



Skiftnyckel



Art.nr.	A mm	L mm
BT112N100	15	100
BT112N150	24	150
BT112N200	28	200
BT112N250	34	250
BT112N300	35	300
BT112N380	45	380
BT112N450	54	450
BT112N600		600

Ringspärrnyckel Kort



Art.nr.	Ø mm	L mm
BT142C8	8	88
BT142C9	9	96
BT142C10	10	96
BT142C11	11	100
BT142C12	12	104
BT142C13	13	108
BT142C14	14	114
BT142C15	15	118
BT142C16	16	122
BT142C17	17	128
BT142C18	18	132
BT142C19	19	138

Lednyckel



Art.nr.	Ø mm	L mm
BT8067	6x7	170
BT8089	8x9	176
BT80810	8x10	179
BT801011	10x11	182
BT801213	12x13	228
BT801415	14x15	232
BT801317	13x17	231
BT801617	16x17	234
BT801819	18x19	285
BT801922	19x22	287
BT802022	20x22	289
BT802123	21x23	289
BT802427	24x27	405
BT803032	30x32	413

Ringnyckel Öppen



Art.nr.	Ø mm	L mm
BT94810	8x10	140
BT94911	9x11	153
BT941011	10x11	153
BT941113	11x13	175
BT941214	12x14	175
BT941415	14x15	175
BT941417	14x17	195
BT941719	17x19	212
BT941922	19x22	228
BT942224	22x24	242
BT942427	24x27	260
BT943032	30x32	300
BT943641	36x41	320

Spärrnyckel

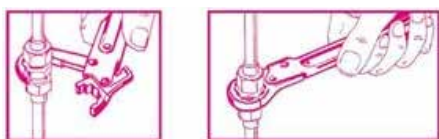

Art.nr.	Ø mm	L mm
BT12010	10	135
BT12011	11	135
BT12012	12	135
BT12013	13	135
BT12014	14	135
BT12017	17	185
BT12019	19	185
BT12022	22	230
BT12024	24	230
BT12027	27	230
BT12030	30	320
BT12032	32	320

Haknyckel



Art.nr.	Ø mm	B mm
BT9912	12-14	1,5
BT9916	16-18-20	1,8
BT9922	22-25-28	1,8
BT9930	30-32	2,1
BT9934	34-36-38	2,4
BT9940	40-42	2,4
BT9945	45-50	2,5
BT9952	52-55-58	2,5
BT9962	62-65	3,1
BT9968	68-70-75	3,1
BT9980	80-85-90	3,8
BT9992	92-95	4,3
BT9998	98-100	4,3
BT99105	105-110-115	4,4
BT99120	120-125-130	4,9
BT99135	135-145	6,0
BT99155	155-165	6,0

Vinkelnyckel 6-kant



Art.nr.	Ø mm	L mm	L1 mm
BT9615	1,5	45	15
BT962	2,0	50	17
BT9625	2,5	57	20
BT963MM	3,0	64	22
BT9635	3,5	68	25
BT964	4,0	72	28
BT9645	4,5	78	30
BT965	5,0	83	32
BT966	6,0	94	37
BT967	7,0	99	40
BT968	8,0	105	43
BT969	9,0	111	46
BT9610	10	119	49
BT9611	11	126	52
BT9612	12	134	56
BT9613	13	142	62
BT9614	14	151	69
BT9616	16	165	75
BT9617	17	174	79
BT9619	19	196	88
BT9622	22	216	100
BT9624	24	242	112
BT9627	27	271	125
BT9630	30	309	140
BT9632	32	341	155
BT9636	36	385	174

Startmotornyckel



Art.nr.	Ø mm	L mm
BT83810	8x10	126
BT831012	10x12	137
BT831113	11x13	138
BT831417	14x17	183
BT831517	15x17	184
BT831618	16x18	196
BT831922	19x22	231

Haknyckel



Art.nr.	Ø mm	B mm
BT99SQ1535	15-35	2,7
BT99SQ3550	35-50	3,5
BT99SQ5080	50-80	4,7
BT99SQ80120	80-120	6,2
BT99SQ120180	120-180	7,8

Vinkelnyckel Med kula



Art.nr.	Ø mm	L mm	L1 mm
BT96BP15	1,5	79	13
BT96BP2	2	84	15
BT96BP2,5	2,5	89	17
BT96BP3	3	99	19
BT96BP4	4	108	24
BT96BP5	5	126	27
BT96BP6	6	148	31
BT96BP8	8	168	35
BT96BP10	10	187	39

Haknyckel

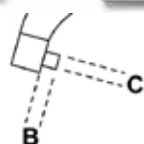

Art.nr.	Ø mm	B mm	C mm
BT99ST15	15-35	2,5	3,0
BT99ST35	35-50	4,5	4,0
BT99ST50	50-80	5,0	5,0
BT99ST80	80-120	7,0	6,0
BT99ST120	120-180	9,0	8,0

Sexkantsnyckel



Art.nr. Ø tum L mm L1 mm

BT96AS130	1/30	44	14
BT96AS120	1/20	44	15
BT96AS116	1/16	46	16
BT96AS564	5/64	50	18
BT96AS332	3/32	53	19
BT96AS764	7/64	57	21
BT96AS18	1/8	60	22
BT96AS964	9/64	64	24
BT96AS532	5/32	68	25
BT96AS316	3/16	75	29
BT96AS732	7/32	82	32
BT96AS14	1/4	89	35
BT96AS516	5/16	103	40
BT96AS38	3/8	117	44
BT96AS716	7/16	132	49
BT96AS12	1/2	149	54

T-nyckelsats 6-kant



Art.nr. Ø mm

BT96TSP11 2-2,5-3-3,5-4-4,5
5-5,5-6-7-8-10

T-nyckel 6-kant, med kula



Art.nr. Ø mm L mm L1 mm

BT96TBP25	2,5	153	55
BT96TBP3	3	153	55
BT96TBP4	4	179	70
BT96TBP5	5	200	84
BT96TBP6	6	220	95
BT96TBP8	8	255	114

T-nyckel 6-kant, med knut

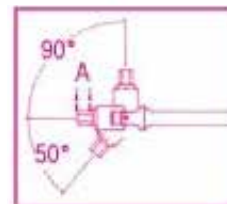

Art.nr. Ø mm L mm H mm

BT9533	3	395	5
BT95335	3,5	395	6
BT9534	4	395	6
BT95345	4,5	395	7
BT9535	5	395	7
BT9536	6	400	9
BT9537	7	425	10
BT9538	8	425	11
BT95310	10	440	13

T-nyckel 6-kant



Art.nr. Ø mm L mm L1 mm

BT96T2	2	139	52
BT96T25	2,5	153	55
BT96T3	3	153	55
BT96T35	3,5	179	70
BT96T4	4	179	70
BT96T45	4,5	200	84
BT96T5	5	200	84
BT96T6	6	220	95
BT96T7	7	236	106
BT96T8	8	255	114
BT96T10	10	285	132

T-nyckel 6-kant



Art.nr. Ø mm L mm L1 mm A1 mm

BT9512	2	125	63	4
BT95125	2,5	150	63	4
BT9513	3	150	63	4
BT95135	3,5	175	76	5,5
BT9514	4	175	70	5,5
BT95145	4,5	195	87	6,5
BT9515	5	195	87	6,5
BT9516	6	215	99	8
BT9517	7	230	109	9
BT9518	8	250	122	10
BT9519	9	265	132	11
BT95110	10	280	142	12
BT95112	12	305	160	15
BT95114	14	330	178	17

Vinkelnnyckelsats Tum, med kula



Art.nr. Ø

CT827	1/16", 5/64", 3/32", 1/8", 5/32", 3/16", 1/4", 5/16", 3/8"
CT829	1.5, 2, 2.5, 3, 4, 5, 6, 8, 10mm

Lednyckelsats Insex



Art.nr. L mm Ø mm

SRWR192105B	220-260	2, 2.5, 3, 4, 5, 6, 8, 10, 12, 14
--------------------	---------	--------------------------------------

Vinkelnnyckel Torx



Art.nr. Ø mm L mm L1 mm

BT97TX6	6	42	16
BT97TX7	7	48	16
BT97TX8	8	48	16
BT97TX9	9	48	16
BT97TX10	10	51	17
BT97TX15	15	54	18
BT97TX20	20	57	19
BT97TX25	25	60	20
BT97TX27	27	64	21
BT97TX30	30	70	24
BT97TX40	40	76	26
BT97TX45	45	83	29
BT97TX50	50	95	32
BT97TX55	55	108	35
BT97TX60	60	120	38

T-nyckel Torx



Art.nr. Ø mm L mm L1 mm

BT97TTX6	6	130	52
BT97TTX7	7	130	52
BT97TTX8	8	139	52
BT97TTX9	9	139	52
BT97TTX10	10	153	55
BT97TTX15	15	153	55
BT97TTX20	20	179	70
BT97TTX25	25	179	70
BT97TTX27	27	200	84
BT97TTX30	30	200	84
BT97TTX40	40	220	95
BT97TTX45	45	236	106
BT97TTX50	50	255	114

Vinkelnnyckelsats Torx med kula



Art.nr.	L mm	Ø
JEAK7146	95-235	T10, T15, T20, T25, T27, T30, T40, T45, T50

Vinkelnnyckelsats Torx



Art.nr.	Ø
BT97BTXB8	T9, T10, T15, T20, T25, T27, T30, T40

T-nyckel Torx



Art.nr. Ø L mm L1 A1

BT951TX6	T6	125	63	4
BT951TX7	T7	125	63	4
BT951TX8	T8	125	63	4
BT951TX9	T9	125	63	4
BT951TX10	T10	150	63	4
BT951TX15	T15	150	63	4
BT951TX20	T20	175	76	5
BT951TX25	T25	175	76	5
BT951TX27	T27	195	87	6
BT951TX30	T30	195	87	6
BT951TX40	T40	215	99	7
BT951TX45	T45	230	109	8
BT951TX50	T50	250	122	9

Skafthylsa 6-kant, hylsa

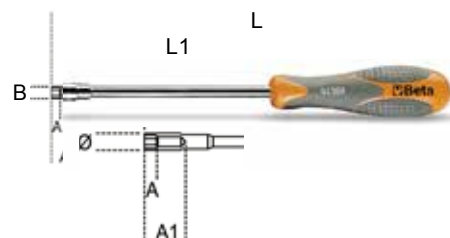

Art.nr.	Ø	L	L1	A	A1	B
BT943BM4	4	270	150	3	13	6,5
BT943BM5	5	270	150	3,5	14	7,6
BT943BM55	5,5	270	150	4	14,5	8,2
BT943BM6	6	270	150	5	14,5	8,8
BT943BM7	7	270	150	6	15,5	10
BT943BM8	8	282	150	7	18,5	11,2
BT943BM9	9	282	150	8	19,5	12,6
BT943BM10	10	282	150	8,5	20,5	13,8
BT943BM11	11	282	150	9	21,5	15,1
BT943BM12	12	282	150	9,5	22,5	16,4
BT943BM13	13	282	150	10,5	23,5	17,6
BT943BM14	14	282	150	11,5	24,5	18,8

Vinkelnnyckel Torx med hål



Art.nr. Ø mm L mm L1 mm

BT97RTX9	9	56	16
BT97RTX10	10	62	17
BT97RTX15	15	72	17
BT97RTX20	20	83	18
BT97RTX25	25	90	18
BT97RTX27	27	100	20
BT97RTX30	30	105	24
BT97RTX40	40	112	26



T-skafthylsa

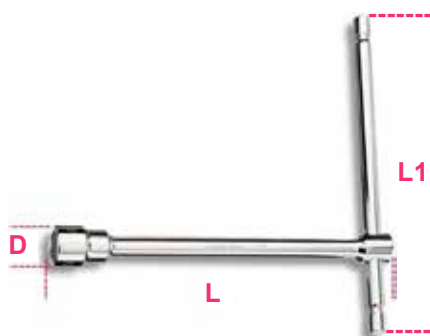

Art.nr.	Ø	L mm	L1	D
BT9506	6	210	145	10,1
BT9507	7	212	145	11,2
BT9508	8	220	160	12,4
BT9509	9	223	160	13,5
BT95010	10	230	160	14,9
BT95011	11	233	160	16,1
BT95012	12	240	175	17,5
BT95013	13	244	175	19,7
BT95014	14	250	190	20,1
BT95015	15	254	190	21,5
BT95016	16	260	200	22,7
BT95017	17	264	200	24,1
BT95019	19	274	230	26,6
BT95022	22	290	290	29,9
BT95024	24	300	320	32,2
BT95027	27	315	370	36,2

Slangklammermejsel Flex 6-kant



Art.nr.	Ø mm	L mm
E2135	5	250
E2136	6	250
E2137	7	250
E2138	8	250
E21310	10	275

Fil 5st olika varianter



Art.nr.	Nr.	Typ	L mm
BT17191	1	Fyrkantsfil	200
BT17192	2	Trekantsfil	200
BT17293	3	Ansatsfil	200
BT17194	4	Halvrundfil	200
BT17195	5	Rundfil	200

T-nyckelsats Torx



Art.nr.	Ø mm
BT951TXS13	T6-T7-T8-T9-T10 T15-T20-T25-T27 T30-T40-T45-T50

Filsats 5st olika varianter



Art.nr.	Typ
BT1719AS5	Fyrkantsfil, Trekantsfil Ansatsfil, Halvrundfil, Rundfil

T-skaft Knuthylsa 6-kant

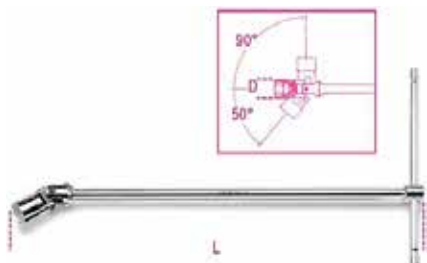

Art.nr.	Ø mm	L mm	D mm
BT9526	6	395	9,5
BT9527	7	395	10,7
BT9528	8	395	12,1
BT9529	9	395	13,2
BT95210	10	400	14,6
BT95211	11	400	15,8
BT95212	12	400	17,0
BT95213	13	432	18,7
BT95214	14	432	19,7
BT95215	15	450	20,9
BT95216	16	450	22,0
BT95217	17	450	23,4
BT95218	18	450	24,7
BT95219	19	500	26,0
BT95220	20	500	27,4
BT95221	21	500	28,5
BT95222	22	500	29,7
BT95224	24	500	32,4

Bågfil Bimetall



Art.nr.	L mm	L1 mm
BT1726	440	300

Bågfilblad HSS Bimetall & Cobolt



Art.nr.	L mm
BT1728BM	300
BT1728CO	300

Filskaft



Art.nr.	L mm	A mm
BT1719R1	110	29
BT1719R2	123	31

Nålfilsats 6st



Art.nr.	L mm
BT1720B6	160

Kontaktfil 6st



Art.nr.	L mm
BT1721B6	142

Slagfil



Art.nr.	L mm	Vikt g
BT1335	375	500

Pansarfilhållare Av aluminium med ställskruv.



Art.nr.
E1640

Filhållare Pansarfilshållare i trä



Art.nr.
BVSY83796

Pansarblad Flat & halvrund



Art.nr.	Typ	1"
BV330141	Flat	9
BV331141	Halvrund	9

Gängtappsats Tum, Kromstål



Art.nr.	Ø tum
BT430ASW18	1/8
BT430ASW532	5/32
BT430ASW316	3/16
BT430ASW14	1/4
BT430ASW516	5/16
BT430ASW38	3/8
BT430ASW716	7/16
BT430ASW12	1/2
BT430ASW916	9/16
BT430ASW58	5/8
BT430ASW34	3/4
BT430ASW78	7/8
BT430ASW1	1

Gängtappsats Kromstål



Art.nr.	Ø mm
BT4302	M2x0.4
BT4303	M3x0.5
BT4304	M4x0.7
BT4305	M5x0.8
BT4306	M6x1
BT4307	M7x1
BT4308	M8x1.25
BT4309	M9x1.25
BT43010	M10x1.5
BT43011	M11x1,5
BT43012	M12 x 1.75
BT43014	M14 x 2
BT43016	M16 x 2
BT43018	M18 x 2,5
BT43020	M20x2.5
BT43022	M22 x 2.5
BT43024	M24 x 3

Gängtappsats HSS



Art.nr.	Ø mm
BT4313	3x0,5
BT4314	4x0,7
BT4315	5x0,8
BT4316	6x1
BT4317	7x1
BT4318	8x1,25
BT43110	10x1,5
BT43112	12x1,75
BT43114	14x2
BT43116	16x2
BT43118	18x2,5
BT43120	20x2,5
BT43122	22x2,5
BT43124	24x3



Gängtappsats MF Kromstål



Art.nr.	Ø mm
BT4336075	6x0,75
BT4337075	7x0,75
BT4338075	8x0,75
BT43381	8x1
BT4339075	9x0,75
BT43391	9x1
BT43310075	10x0,75
BT433101	10x1
BT43310125	10x1,25
BT43311075	11x0,75
BT433111	11x1
BT43311125	11x1,25
BT43312075	12x0,75
BT433121	12x1
BT43312125	12x1,25
BT43312150	12x1,5
BT433141	14x1
BT43314125	14x1,25
BT43314150	14x1,5
BT433161	16x1
BT43316150	16x1,50
BT43318150	18x1,5
BT433182	18x2
BT43320150	20x1,5
BT43322150	22x1,5
BT43324150	24x1,5
BT433242	24x2

Gängtappsats UNF, kromstål



Art.nr.	Ø tum
BT433ASF14	1/4x28
BT433ASF516	5/16x24
BT433ASF38	3/8x24
BT433ASF716	7/16x20
BT433ASF12	1/2x20
BT433ASF916	9/16x18
BT433ASF58	5/8x18
BT433ASF34	3/4x16
BT433ASF78	7/8x14
BT433ASF1	1x12

Gängsnitt Kromstål



Art.nr.	M
BT4402	2x0,4
BT4403	3x0,5
BT4404	4x0,7
BT4405	5x0,8
BT4406	6x1
BT4407	7x1
BT4408	8x1,25
BT4409	9x1,25
BT44010	10x1,5
BT44012	12x1,75

Gängtappsats UNC, kromstål



Art.nr.	Ø tum
BT430ASC14	1/4x20
BT430ASC516	5/16x18
BT430ASC38	3/8x16
BT430ASC716	7/16x14
BT430ASC12	1/2x13
BT430ASC916	9/16x12
BT430ASC58	5/8x11
BT430ASC34	3/4x10
BT430ASC78	7/8x9
BT430ASC1	1x8

Gängtappsats ASG, kromstål



Art.nr.	Ø tum
BT433ASG18	1/8x28
BT433ASG14	1/4x19
BT433ASG38	3/8x19
BT433ASG12	1/2x14
BT433ASG34	3/4x14
BT433ASG1	1x11

Gängsnitt Kromstål



Art.nr.	M
BT4416075	6x0,75
BT4417075	7x0,75
BT4418075	8x0,75
BT44181	8x1
BT4419075	9x0,75
BT44191	9x1

Gängsnitt HSS



Art.nr.	M	ØxS mm
BT4423	3x5	20x5
BT4424	4x0,7	20x5
BT4425	5x0,8	20x7
BT4426	6x1	20x7
BT4427	7x1	25x9
BT4428	8x1,25	25x9
BT44210	10x1,5	30x11
BT44212	12x1,75	38x14
BT44214	14x2	38x14
BT44216	16x2	45x18
BT44218	18x2,5	45x18
BT44220	20x2,5	48x18
BT44222	22x2,5	55x22
BT44224	24x3	55x22

Gängsnitt UNC, Kromstål



Art.nr.	UNC	Ø mm
BT440ASC14	1/4x20	25,4
BT440ASC516	5/16x18	25,4
BT440ASC38	3/8x16	38,1
BT440ASC716	7/16x14	38,1
BT440ASC12	1/2x13	38,1
BT440ASC916	9/16x12	38,1
BT440ASC58	5/8x11	50,8
BT440ASC34	3/4x10	50,8
BT440ASC78	7/8x9	50,8
BT440ASC1	1x8	50,8

Gängsnittshållare



Art.nr.	M	Ø mm
BT441A10075	10x075	38,1
BT441A101	10x1	38,1
BT441A10125	10x1,25	38,1
BT441A11075	11x0,75	38,1
BT441A111	11x1	38,1
BT441A11125	11x1,25	38,1
BT441A12075	12x0,75	38,1
BT441A121	12x1	38,1
BT441A12125	12x1,25	38,1
BT441A1215	12x1,5	38,1
BT441A141	14x1	38,1
BT441A14125	14x1,25	38,1
BT441A1415	14x1,5	38,1
BT441A161	16x1	38,1
BT441A1615	16x1,5	38,1
BT441A1815	18x1,5	38,1

Gängtappshållare



Art.nr.	M	□ mm	L mm
BT4350	M2-M8	2-5	140
BT4351	M3-M10	2-6	180
BT43515	M3-M12	2,5-6	180
BT4352	M4-M12	3-7	260
BT4353	M5-M20	4-12	380
BT4354	M9-M27	5,5-16	490
BT4355	M13-M32	7-18	620

Gängsnittshållare



Art.nr.	Ø mm	L mm
BT444	20x5	215
BT4440	20x7	215
BT4441	25,4	225
BT4441A	25x9	225
BT4441B	30x11	300
BT444C	38xx10	315
BT4441C	38x14	315
BT4442	38,2x14	360
BT4441D	45x14	455
BT4442D	45x18	455
BT4443	50,8	555
BT4444	55x16	555
BT4445A	63,5	630

Gängsnitt UNF, Kromstål



Art.nr.	UNF	Ø mm
BT440ASF14	1/4x28	25,4
BT440ASF516	5/16x24	25,4
BT440ASF38	3/8x24	38,1
BT440ASF716	7/16x20	38,1
BT440ASF12	1/2x20	38,1
BT440ASF916	9/16x18	38,1
BT440ASF58	5/8x18	50,8
BT440ASF34	3/4x16	50,8
BT440ASF78	7/8x14	50,8
BT440ASF1	1x12	50,8

Gängsnitt HSS Rörgänga, GAS



Art.nr.	GAS	ØxS mm
BT442ASG18	1/8X28	30x11
BT442ASG14	1/4x19	38x10
BT442ASG38	3/8x19	45x14
BT442ASG12	1/2x14	45x14
BT442ASG58	5/8x14	55x16
BT442ASG34	3/4x14	55x16
BT442ASG78	7/8x14	65x18
BT442ASG1	1x11	65x18

Gängtappshållare Kort



Art.nr.	M	□ mm	L mm
BT4361	M3-M8	2-5	85
BT4362	M5-M12	4,6-8	110

Gängtappshållare Lång



Art.nr.	M	□ mm	L mm
BT436L1	M3-M8	2-5	245
BT436L2	M5-M12	4,6-8	295

Gängfil



Art.nr.	Typ	L mm
E2581	Millimeter	230
E2582	Tum	230

Gängtappsats 3-12 mm



Art.nr.	Ø mm
BT430SP21	M3-M4-M5-M6 M8-M10-M12



Gängsats 3-12 mm



430	440		
M mm	M mm		
3x0,5	3x0,5	43515	4441
4x0,7	4x0,7		
5x0,8	5x0,8		
6x1	6x1		
8x1,25	8x1,25		
10x1,5	10x1,5		
12x1,75	12x1,75		

Art.nr.
BT446C30

Gängsats UNC 1/4 - 3/4



430ASC	440ASC		
1/4	1/4	43515	4441
5/16	5/16	4353	4442
3/8	3/8		4443
7/16	7/16		
1/2	1/2		
9/16	9/16		
5/8	5/8		
3/4	3/4		

Art.nr.
BT446ASCC37

Gängsats 2-16 mm



430	433	440	441
M mm	M mm	M mm	M mm
		440A	441A
2x0,4	6x0,75	2x0,4	6x0,75
3x0,5	7x0,75	3x0,5	7x0,75
4x0,7	8x0,75	4x0,7	8x0,75
5x0,8	8x1	5x0,8	8x1
6x1	9x0,75	6x1	9x0,75
7x1	9x1	7x1	9x1
8x1,25	10x0,75	8x1,25	10x0,75
9x1,25	10x1	9x1,25	10x1
10x1,5	10x1,25	10x1,5	10x1,25
11x1,5	11x0,75	11x1,5	11x0,75
12x1,75	11x1	12x1,75	11x1
14x2	11x1,25	14x2	11x1,25
16x2	12x0,75	16x2	12x0,75
	12x1		12x1
	12x1,25		12x1,25
	12x1,5		12x1,5
	14x1		14x1
	14x1,25		14x1,25
	14x1,5		14x1,5
	16x1		16x1
	16x1,5		16x1,5
	18x1,5		18x1,5



435/0	444/1	436/1
435/3	444/2	

Art.nr.
BT446C110

Gängsats UNF 1/4 - 3/4



430ASF	440ASF		
1/4	1/4	43515	4441
5/16	5/16	4353	4442
3/8	3/8		4443
7/16	7/16		
1/2	1/2		
9/16	9/16		
5/8	5/8		
3/4	3/4		

Art.nr.

BT446ASFC29

Gängrepsats



Art.nr.	M
MU505000	M5-M10
MU505004	M4
MU505005	M5
MU505006	M6
MU505007	M7
MU505008	M8
MU505208	M8x1
MU505010	M10
MU505210	M10x1,25
MU505012	M12
MU505812	M12x1,25
MU505212	M12x1,5
MU505014	M14
MU505412	M14x1,25
MU505214	M14x1,5
MU505016	M16
MU505216	M16x1,5
MU505018	M18
MU505218/L	M18x1,5

Gäng & Borrsets HSS 1/4"



För borring, gängning och försänkning. Magnethållare ingår.

Art.nr.	M
BT438A	M3-M4-M5-M6-M8-M10

Gängrepsats M5-12



Art.nr.	M
BT437U09	M5x0,8 / M6x1,0 / M8x1,25 M10x1,5 / M12x1,75

Gängsats W 1/8 - 1/2



430ASW	440ASW		
1/8	1/8	43515	4441
5/32	5/32	4352	4442
3/16	3/16		
1/4	1/4		
5/16	5/16		
3/8	3/8		
7/16	7/16		
1/2	1/2		

Art.nr.

BT446ASWC36

Gängor 10st



Art.nr.	M
MU505104	M4
MU505105	M5
MU505106	M6
MU505107	M7
MU505108	M8
MU505308	M8x1
MU505110	M10
MU505310	M10x1,25
MU505112	M12
MU505313	M12x1,25
MU505312	M12x1,5
MU505114	M14
MU505414	M14x1,25
MU505314	M14x1,5
MU505116	M16
MU505316	M16x1,5
MU505118	M18
MU505318/L	M18x1,5

Smideshammare



Art.nr.	Vikt g	L mm	L1 mm
BT1370100	100	260	82
BT1370200	200	280	95
BT1370300	300	300	105
BT1370400	400	310	112
BT1370500	500	320	118
BT1370600	600	330	122
BT1370800	800	350	130
BT13701000	1000	360	135
BT13701500	1500	380	145
BT13702000	2000	400	155

Skaft Till BT1370



Art.nr.
BT1370MR100
BT1370MR200
BT1370MR300
BT1370MR400
BT1370MR500
BT1370MR600
BT1370MR800
BT1370MR1000
BT1370MR1500
BT1370MR2000

Smideshammare



Art.nr.	Vikt g	L mm	L1 mm
BT1370T200	200	280	95
BT1370T300	300	300	105
BT1370T500	500	320	118
BT1370T800	800	350	130
BT1370T1000	1000	360	135
BT1370T1500	1500	365	145

Skaft Till BT1378



Art.nr.

- BT1378MR340**
- BT1378MR570**

Kopparslägga



Art.nr.	L mm	L1 mm	Vikt g
BT1385400	260	75	400
BT1385600	270	80	600
BT1385800	280	90	800
BT13851000	280	100	1000
BT13851500	280	110	1500
BT13852000	300	120	2000

Kulhammare



Art.nr.	L mm	L1 mm	Vikt g
BT1377340	330	95	340
BT1377450	350	102	450
BT1377570	350	110	570
BT1377680	360	116	680
BT1377900	380	120	900

Smidesslägga



Art.nr.	L mm	L1 mm	Vikt g
BT1380800	260	90	800
BT13801000	260	95	1000
BT13801250	260	100	1250
BT13801500	280	110	1500
BT13802000	300	120	2000

Skaft Till BT1385



Art.nr.

- BT1385MR400**
- BT1385MR600**
- BT1385MR800**
- BT1385MR1000**
- BT1385MR1500**
- BT1385MR2000**

Skaft Till BT1377



Art.nr.

- BT1377MR340**
- BT1377MR450**
- BT1377MR570**
- BT1377MR680**
- BT1377MR900**

Skaft Till BT1380



Art.nr.

- BT1380MR800**
- BT1380MR1000**
- BT1380MR1250**
- BT1380MR1500**
- BT1380MR2000**

Plastklubba



Art.nr.	L mm	L1 mm	Vikt g
BT139135	280	90	35
BT139150	320	105	50
BT139155	355	110	55
BT139165	380	130	65

Penhammare



Art.nr.	L mm	L1 mm	Vikt g
BT1378340	330	100	340
BT1378570	350	115	570

Slägga



Art.nr.	L mm	L1 mm	Vikt g
BT13813000	800	142	3000
BT13814000	900	152	4000
BT13815000	900	162	5000
BT13818000	900	185	8000

Plasthammare



Art.nr.	L mm	L1 mm	Vikt g
BT139022	260	70	22
BT139028	280	85	28
BT139035	310	95	35
BT139045	320	107	45
BT139060	380	128	60

Skaft Till 1390



Art.nr.

- BT1390MR22**
- BT1390MR28**
- BT1390MR35**
- BT1390MR45**
- BT1390MR60**

1/4"

T-dragskaft 1/4"



Art.nr.

L mm

KT2785

115

Plastslag



Art.nr.

- BT1390R28**
- BT1390R35**
- BT1390R45**
- BT1390R60**

Spärrskaft 1/4"

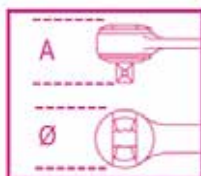

Art.nr.

L mm

Ø mm

A mm

BT90055

125

25

18

Dragskaft 1/4" Ledat

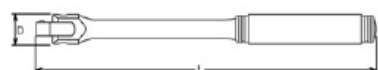

Art.nr.

L mm

D mm

KT2768J

130

14

Studsfri hammare



Mått i mm

L

L1

D

BT139230

300

105

30

BT139235

305

115

35

BT139240

310

125

40

BT139250

325

135

50

Spärrskaft 1/4" Ledat



Art.nr.

L mm

D mm

T mm

H mm

KT2774J

161

22

18,7

11,4

Vev 1/4"



Art.nr.

L mm

KT2780

350

Slägga I polyeten



Art.nr.

L mm

Vikt kg

SW65506700

900

5

Dragskaft 1/4" Ledat



Art.nr.

L mm

L1 mm

BT90035

148

84

Mejselhandtag 1/4" Ledat



Art.nr.

L mm

KT2769H

160

Hylsa 1/4" 6-Kant



Dessa finns även i 12-kant **KT2405**

Art.nr.	Ø mm
KT2400M3	3
KT2400M4	4
KT2400M45	4,5
KT2400M5	5
KT2400M55	5,5
KT2400M6	6
KT2400M7	7
KT2400M8	8
KT2400M9	9
KT2400M10	10
KT2400M11	11
KT2400M12	12
KT2400M13	13
KT2400M14	14

Hylsa 1/4" 6-Kant Lång 50mm



Dessa finns även i 12-kant **KT2305**

Art.nr.	Ø mm
KT23003	3
KT23004	4
KT23004,5	4,5
KT23005	5
KT230055	5,5
KT23006	6
KT23007	7
KT23008	8
KT23009	9
KT230010	10
KT230011	11
KT230012	12
KT230013	13
KT230014	14



Hylsa 1/4" Torx



Art.nr.	TX
KT2425E4	4
KT2425E5	5
KT2425E6	6
KT2425E7	7
KT2425E8	8
KT2425E10	10

Hylsa 1/4" Lång 50mm Torx



Art.nr.	TX
KT2325E4	4
KT2325E5	5
KT2325E6	6
KT2325E7	7
KT2325E8	8
KT2325E10	10

Hylsa 1/4" 6-Kant Tum



Dessa finns även i 12-kant **KT2405**

Art.nr.	Tum
KT2400A18	1/8
KT2400A532	5/32
KT2400A316	3/16
KT2400A732	7/32
KT2400A14	1/4
KT2400A932	9/32
KT2400A516	5/16
KT2400A1132	11/32
KT2400A38	3/8
KT2400A716	7/16
KT2400A12	1/2
KT2400A916	9/16

Hylsa 1/4" 6-Kant Tum Lång 50mm



Dessa finns även i 12-kant **KT2305**

Art.nr.	Tum
KT2300A18	1/8
KT2300A532	5/32
KT2300A316	3/16
KT2300A732	7/32
KT2300A14	1/4
KT2300A932	9/32
KT2300A516	5/16
KT2300A1132	11/32
KT2300A38	3/8
KT2300A716	7/16
KT2300A12	1/2
KT2300916	9/16

Krafthylsa 1/4" Torx



Art.nr.	TX
KT12425E4	4
KT12425E5	5
KT12425E6	6
KT12425E7	7
KT12425E8	8
KT12425E10	10

[TORX®]

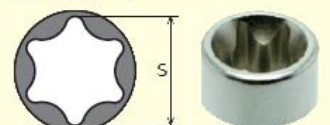

S TORX® S
(ref. mm) (E) (ref. mm)

E 4	3.83	E12	11.12
E 5	4.72	E14	12.85
E 6	5.69	E16	14.71
E 7	6.17	E18	16.64
E 8	7.47	E20	18.41
E10	9.37	E22	20.24
E11	10.03	E24	22.10

Insextapp 1/4"



Art.nr.	Dim.	L mm
KT2010M253	3	25
KT2010M254	4	25
KT2010M255	5	25
KT2010M256	6	25
KT2010M257	7	25
KT2010M258	8	25
KT2010M2510	10	25

Torxtapp 1/4" Lång 80 mm



Art.nr.	Dim.	L mm
KT2025T8010	10	80
KT2025T8015	15	80
KT2025T8020	20	80
KT2025T8025	25	80
KT2025T8027	27	80
KT2025T8030	30	80
KT2025T8040	40	80

Penta-Lobe (PR)

	S (ref. mm)	S (ref. mm)
8PR	2.19	40PR 6.30
10PR	2.58	45PR 7.38
15PR	3.10	50PR 8.35
20PR	3.64	55PR 10.63
25PR	4.12	
27PR	4.71	
30PR	5.23	

Insextapp 1/4" Lång 100 mm



Art.nr.	Dim.	L mm
KT2010M1003	3	100
KT2010M1004	4	100
KT2010M1005	5	100
KT2010M1006	6	100
KT2010M1007	7	100
KT2010M1008	8	100
KT2010M10010	10	100

Penta-Lobetapp 1/4"



Art.nr.	Dim.	L mm
KT2025PR8	8	28
KT2025PR9	9	28
KT2025PR10	10	28
KT2025PR15	15	28
KT2025PR20	20	28
KT2025PR25	25	28
KT2025PR27	27	28
KT2025PR30	30	28
KT2025PR40	40	28

Torx-Plustappsats 1/4"



	S (ref. mm)	S (ref. mm)
8IP	2.29	30IP 5.49
9IP	2.48	40IP 6.60
10IP	2.72	45IP 7.77
15IP	3.25	50IP 8.79
20IP	3.84	55IP 11.16
25IP	4.39	60IP 13.20
27IP	4.95	

Art.nr.	IP
KTRS2025IP7	10-15-20-25-27-30-40

XZN-tapp 1/4" Kort & Lång



Art.nr.	Dim.	L mm
KT2020M284	4	28
KT2020M285	5	28
KT2020M286	6	28
KT2020M288	8	28
KT2020M504	4	50
KT2020M505	5	50
KT2020M506	6	50
KT2020M508	8	50

Penta-Lobetappsats 1/4"



Art.nr.	PR
KTRS2025PR7	10-15-20-25-27-30-40

Förstoring 1/4"x3/8"



Art.nr.	Ø tum	L mm
KT2233	1/4"x3/8"	22

Torxtapp 1/4"



Art.nr.	Dim.	L mm
KT2025T2810	10	28
KT2025T2815	15	28
KT2025T2820	20	28
KT2025T2825	25	28
KT2025T2827	27	28
KT2025T2830	30	28
KT2025T2840	40	28

Torx-Plustappar 1/4"



Art.nr.	Dim.	L mm
KT2025IP8	8	28
KT2025IP9	9	28
KT2025IP10	10	28
KT2025IP15	15	28
KT2025IP20	20	28
KT2025IP25	25	28
KT2025IP27	27	28
KT2025IP30	30	28
KT2025IP40	40	28

Förlängare 1/4"



Art.nr.	L mm
KT276028	28
KT276050	50
KT2760100	100
KT2760150	150
KT2760200	200
KT2760250	250
KT2760300	300
KT2760350	350
KT2760400	400
KT2760600	600

Förlängare Wobblade



Art.nr.	L mm
KT276328	28
KT276350	50
KT276375	75
KT2760100	100
KT2760150	150
KT2760200	200
KT2760250	250
KT2760350	350
KT2760400	400

Hylsats 1/4"



BT903C35

Dragskraft 3/8" Ledat

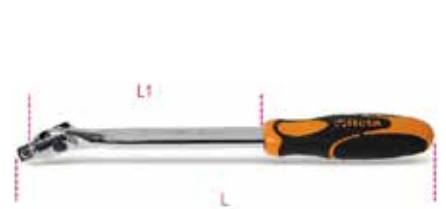

Art.nr.	L mm	L1 mm
BT91036	255	154

Universalknut 1/4"



Art.nr.	L mm
KT2770	33

3/8"

Dragskraft 3/8"



Art.nr.	L mm
KT3768P380	380

Hylsats 1/4"



1/4" Sq Drive Standard Sockets:
4, 4.5, 5, 5.5, 6, 7, 8, 9, 10, 11, 12, 13, 14mm,
1/4" Sq Drive Deep Sockets: 4, 4.5, 5, 5.5, 6, 7, 8, 9, 10, 11, 12, 13, 14mm,
Extension Bars; 75, 150mm,
1/4" Sq Drive 72-Tooth Gear-to-Gear Flip Reverse Ratchet Wrench with Quick Release, Spinner Handle, Universal Joint, 3/8" Sq Drive - 1/4" Sq Drive Male Adaptor

Art.nr.
JEA7950

Spärrskraft 3/8"



Art.nr.	L mm	Ø mm	A mm
BT91055	178	30	26

Mejselhandtag 3/8" Ledat



Art.nr.	L mm
KT3769H	170

Spärrskraft 3/8" Ledat



Art.nr.	L mm
KT3776J	280

Spärrskraft 3/8" Ledat



Art.nr.	L mm
KT3774J	285

Momentnyckel 3/8"



Art.nr.	Dim.	L mm
KT3751J	25Nm	178

Momentadapter 3/8"



Art.nr.	Dim.	L mm
KT370120	20Nm	75
KT370130	30Nm	75

Kräkfotsats 3/8" Tum 6-kant 8st



Art.nr.	Dim. tum
JEAK599	3/8", 7/16", 1/2", 9/16", 5/8", 11/16", 3/4", 7/8"

Förlängare 3/8"



Art.nr.	L mm
KT376032	32
KT376050	50
KT376075	75
KT3760125	125
KT3760150	150
KT3760250	250
KT3760300	300
KT3760400	400
KT3760500	500
KT3760600	600
KT3760900	900
KT37601000	1000

Kulknut 3/8"



Art.nr.	L mm
KT3771	43



Förlängare 3/8" Wobbel



Art.nr.	L mm
KT376332	28
KT376350	50
KT376375	75
KT3763125	125
KT3763150	150
KT3763250	250
KT3763300	300

Förminskning & Förstoring 3/8"



Art.nr.	Typ	Ø tum	L mm
KT3322	Förminskning	3/8"x1/4"	24
KT3344	Förstoring	3/8"x1/2"	30

Hylsor 3/8" 6-Kant



Dessa finns även i 12-kant **KT3405**

Art.nr.	Ø mm	Längd
KT3400M6	6	26
KT3400M7	7	26
KT3400M8	8	26
KT3400M9	9	26
KT3400M10	10	26
KT3400M11	11	26
KT3400M12	12	26
KT3400M13	13	26
KT3400M14	14	27
KT3400M15	15	28
KT3400M16	16	28
KT3400M17	17	29
KT3400M18	18	30
KT3400M19	19	30
KT3400M20	20	31
KT3400M21	21	32
KT3400M22	22	32
KT3400M23	23	33
KT3400M24	24	34

Förlängare 3/8" Flex



Art.nr.	L mm
KT3762	300

Kräkfotsats 3/8" 6-kant 10st



Art.nr.	Dim.
JEAK598	10, 11, 12, 13, 14, 15, 16, 17, 18, 19

Hylsor 3/8" 6-Kant Tum



Dessa finns även i 12-kant **KT3405A**

Art.nr.	Ø tum	Längd
---------	-------	-------

KT3400A14	1/4	26
KT3400A516	5/16	26
KT3400A1132	11/32	26
KT3400A38	3/8	26
KT3400A716	7/16	26
KT3400A12	1/2	26
KT3400A916	9/16	27
KT3400A1932	19/32	28
KT3400A58	5/8	28
KT3400A1116	11/16	30
KT3400A34	3/4	30
KT3400A2532	25/32	31
KT3400A1316	13/16	32
KT3400A78	7/8	32
KT3400A1516	15/16	34

Hylsa 3/8" 6-Kant Lång Tum



Dessa finns även i 12-kant **KT3305A**

Art.nr.	Ø tum	Längd
---------	-------	-------

KT3300A14	1/4	55
KT3300A516	5/16	55
KT3300A1132	11/32	55
KT3300A38	3/8	55
KT3300A716	7/16	55
KT3300A12	1/2	55
KT3300A916	9/16	55
KT3300A1932	19/32	55
KT3300A58	5/8	55
KT3300A1116	11/16	55
KT3300A34	3/4	55
KT3300A1316	13/16	55
KT3300A78	7/8	55
KT3300A1516	15/16	55

Krafthylsa 3/8" 6-Kant Tum Kort



Dessa finns även i 12-kant **KT13405A**

Art.nr.	Ø tum	Längd
---------	-------	-------

KT13400A14	1/4"	32
KT13400A56	5/6"	32
KT13400A38	3/8"	32
KT13400A716	7/6"	32
KT13400A12	1/2"	32
KT13400A916	9/16"	32
KT13400A58	5/8"	32
KT13400A1116	11/16"	32
KT13400A34	3/4"	32
KT13400A1316	13/16"	32
KT13400A78	17/8"	32

Hylsa 3/8" 6-Kant Lång 6-Kant



Dessa finns även i 12-kant **KT3305**

Art.nr.	Ø mm.	Längd
---------	-------	-------

KT33006	6	55
KT33007	7	55
KT33008	8	55
KT33009	9	55
KT330010	10	55
KT330011	11	55
KT330012	12	55
KT330013	13	55
KT330014	14	55
KT330015	15	55
KT330016	16	55
KT330017	17	55
KT330018	18	55
KT330019	19	55
KT330020	20	55
KT330021	21	55
KT330022	22	55
KT330023	23	55
KT330024	24	55
KT330025	25	55
KT330026	26	55
KT330027	27	55

Krafthylsa 3/8" Kort 6-Kant



Dessa finns även i 12-kant **KT13405**

Art.nr.	Ø mm	L mm
---------	------	------

KT134006	6	32
KT134007	7	32
KT134008	8	32
KT134009	9	32
KT1340010	10	32
KT1340011	11	32
KT1340012	12	32
KT1340013	13	32
KT1340014	14	32
KT1340015	15	32
KT1340016	16	32
KT1340017	17	32
KT1340018	18	32
KT1340019	19	32
KT1340020	20	32
KT1340021	21	32
KT1340022	22	32
KT1340023	23	32
KT1340024	24	32

Krafthylsa 3/8" 6-Kant Lång



Dessa finns även i 12-kant **KT13305**
(8-10-12-13-14)

Art.nr.	Ø mm	L mm
---------	------	------

KT133006	6	80
KT133007	7	80
KT133008	8	80
KT133009	9	80
KT1330010	10	80
KT1330011	11	80
KT1330012	12	80
KT1330013	13	80
KT1330014	14	80
KT1330015	15	80
KT1330016	16	80
KT1330017	17	80
KT1330018	18	80
KT1330019	19	80
KT1330020	20	80
KT1330021	21	80
KT1330022	22	80

Krafthylsa 3/8" 6-Kant Lång Tum



Art.nr.	Ø tum	Längd
KT13300A34	1/4"	80
KT13300A516	5/16"	80
KT13300A38	3/8"	80
KT13300A716	7/16"	80
KT13300A12	1/2"	80
KT13300A916	9/16"	80
KT13300A58	5/8"	80
KT13300A1116	11/16"	80
KT13300A34	3/4"	80
KT13300A1316	13/16"	80
KT13300A78	7/8"	80

Förlängare 3/8"



Art.nr.	L mm
KT1376075	75
KT13760125	125
KT13760250	250

Insextapp 3/8"



Art.nr.	Dim.	L mm
KT3010M1003	3	100
KT3010M1004	4	100
KT3010M1005	5	100
KT3010M1006	6	100
KT3010M1007	7	100
KT3010M1008	8	100
KT3010M10010	10	100
KT3010M10011	11	100
KT3010M10012	12	100
KT3010M10013	13	100
KT3010M10014	14	100

Tändstifthylsa 3/8" Lång 12-kant



Art.nr.	Dim.	L mm
JEAK6551	14	250
JEAK6552	16	250



Förminskning & Förstoring 3/8"



KT14433



KT13344

Art.nr.	Typ	Ø tum	L mm
KT13322	Förminskning	3/8"x1/4"	25
KT13344	Förstoring	3/8"x1/2"	32,5

Insextapp 3/8"



Art.nr.	Dim.	L mm
KT3010M383	3	38
KT3010M384	4	38
KT3010M385	5	38
KT3010M386	6	38
KT3010M387	7	38
KT3010M388	8	38
KT3010M3810	10	38
KT3010M3811	11	38
KT3010M3812	12	38
KT3010M3813	13	38
KT3010M3814	14	38

Insextapp 3/8"



Art.nr.	Dim.	L mm
KT3012A18	1/8"	52
KT3012A532	5/32"	52
KT3012A316	3/16"	52
KT3012A732	7/32"	52
KT3012A14	1/4"	52
KT3012A932	9/32"	52
KT3012A516	5/16"	52
KT3012A1132	11/32"	52
KT3012A38	3/8"	52
KT3012A716	7/16"	52
KT3012A12	1/2"	52
KT3012A916	9/16"	52

Kraftkulknut 3/8"



Art.nr.	L mm
KT13770	56

Torxtapp 3/8"



Art.nr.	Dim.	L mm
KT3025T509	9	50
KT3025T5010	10	50
KT3025T5015	15	50
KT3025T5020	20	50
KT3025T5025	25	50
KT3025T5027	27	50
KT3025T5030	30	50
KT3025T5040	40	50
KT3025T5045	45	50
KT3025T5050	50	50
KT3025T5055	55	50

Torxtapp 3/8" Med hål



Art.nr.	Dim.	L mm
KT3025TH16025	25	160
KT3025TH16027	27	160
KT3025TH16030	30	160
KT3025TH16040	40	160
KT3025TH16045	45	160
KT3025TH16050	50	160
KT3025TH16055	55	160

Torx Plustapp 3/8"



TORXplus (IP)		S (ref. mm)	S (ref. mm)
		8IP 2.29	30IP 5.49
		9IP 2.48	40IP 6.60
		10IP 2.72	45IP 7.77
		15IP 3.25	50IP 8.79
		20IP 3.84	55IP 11.16
		25IP 4.39	60IP 13.20
		27IP 4.95	

Art.nr.	Dim.	L mm
KT3025IP10	10	50
KT3025IP15	15	50
KT3025IP20	20	50
KT3025IP25	25	50
KT3025IP27	27	50
KT3025IP30	30	50
KT3025IP40	40	50
KT3025IP45	45	50
KT3025IP50	50	50
KT3025IP55	55	50

XZN-tapp 3/8" Kort



Art.nr.	Dim.	L mm
KT3020M385	M5	38
KT3020M386	M6	38
KT3020M388	M8	38
KT3020M3810	M10	38
KT3020M3812	M12	38
KT3020M3814	M14	38

Torxtapp 3/8"



Art.nr.	Dim.	L mm
KT3025T1409	9	140
KT3025T14010	10	140
KT3025T14015	15	140
KT3025T14020	20	140
KT3025T14025	25	140
KT3025T14027	27	140
KT3025T14030	30	140
KT3025T14040	40	140
KT3025T14045	45	140
KT3025T14050	50	140
KT3025T14055	55	140

XZN-tapp 3/8" Lång



Art.nr.	Dim.	L mm
KT3020M1004	M4	100
KT3020M1005	M5	100
KT3020M1006	M5	100
KT3020M1008	M8	100
KT3020M10010	M10	100
KT3020M10012	M12	100
KT3020M10014	M14	100



Torxtapp 3/8" Med hål



Art.nr.	Dim.	L mm
KT3025TH5010	10	50
KT3025TH5015	15	50
KT3025TH5020	20	50
KT3025TH5025	25	50
KT3025TH5027	27	50
KT3025TH5030	30	50
KT3025TH5040	40	50
KT3025TH5045	45	50
KT3025TH5050	50	50
KT3025TH5055	55	50

Penta-Lobetapp 3/8"



Penta-Lobe (PR)		S (ref. mm)	S (ref. mm)
8PR	2.19	40PR	6.30
10PR	2.58	45PR	7.38
15PR	3.10	50PR	8.35
20PR	3.64	55PR	10.63
25PR	4.12		
27PR	4.71		
30PR	5.23		

Art.nr.	Dim.	L mm
KT3025PR10	10	50
KT3025PR15	15	50
KT3025PR20	20	50
KT3025PR25	25	50
KT3025PR27	27	50
KT3025PR30	30	50
KT3025PR40	40	50
KT3025PR45	45	50
KT3025PR50	50	50
KT3025PR55	55	50



Art.nr.	Dim.
KTRS3025PR	PR10 - PR50

1/2"

Dragskaft 1/2"



Art.nr.	L mm	L1 mm
BT92036	408	283

Hylsa LHS 1/2"



Art.nr.	Dim.	L mm
KT4400LH6S	6S	36
KT4400LH8S	8S	37
KT4400LH10S	10S	37
KT4400LH12S	12S	37
KT4400LH14S	14S	37
KT4400LH16S	16S	38

T-dragskaft 1/2"



Art.nr.	L mm
KT4785	300

Ribetapp 3/8"



Art.nr.	Dim.	L mm
KT3027505	M5	50
KT3027506	M6	50
KT3027507	M7	50
KT3027508	M8	50
KT3027509	M9	50
KT30275010	M10	50
KT30275012	M12	50

Hylsats Multi 1/4", 3/8" & 1/2"



•Deluxe professional socket set with heat treated, mirror polished Chrome Vanadium steel sockets.

•Covers sizes from 4 to 32mm.

•Includes 48-tooth gear-to-gear comfort grip ratchet handles, spark plug sockets, extension bars, female TRX-Star* sockets, socket bits, combination spanners, bits, hex keys and accessories.

•Supplied in tough, durable carry-case.

Art.nr.
JEAK8958

Spärrskaft 1/2"

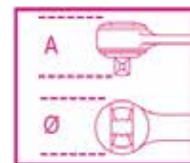

Art.nr.	L mm	A mm	Ø mm
BT92055	275	43	40

Ribetapp 3/8"



Art.nr.	Dim.	L mm
KT30271005	M5	100
KT30271006	M6	100
KT30271007	M7	100
KT30271008	M8	100
KT302710010	M10	100
KT302710012	M12	100

Spärrskaft 1/2" Ledat

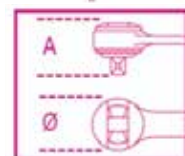

Art.nr.	L mm	A mm	Ø mm
BT92056	315	43	40

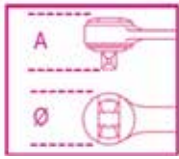
Spärrskaft 1/2"

Art.nr.	L mm	A mm	Ø mm
BT92055X	200	33	30

Dragskaft 1/2" Ledat Extra långt

Art.nr.	L mm
KT50HH600	600
KT50HH750	750

Hylsa 1/2" Kort 6-kant

Dessa finns även i 12-Kant **KT4406**

Art.nr.	Dim.	Längd
---------	------	-------

KT4401M8	8	36
KT4401M9	9	37
KT4401M10	10	37
KT4401M11	11	37
KT4401M12	12	37
KT4401M13	13	37
KT4401M14	14	37
KT4401M15	15	37
KT4401M16	16	37
KT4401M17	17	37
KT4401M18	18	37
KT4401M19	19	38
KT4401M20	20	38
KT4401M21	21	38
KT4401M22	22	40
KT4401M23	23	40
KT4401M24	24	42
KT4401M25	25	42
KT4401M26	26	42
KT4401M27	27	43
KT4401M28	28	43
KT4401M29	29	43
KT4401M30	30	46
KT4401M31	31	46
KT4401M32	32	46
KT4401M33	33	47
KT4401M34	34	47
KT4401M35	35	47
KT4401M36	36	47
KT4401M38	38	47

Dragskaft 1/2"

Art.nr.	L mm
BT920M35	380

Förlängare 1/2"

Art.nr.	L mm
KT476050	50
KT476075	75
KT4760100	100
KT4760125	125
KT4760150	150
KT4760250	250
KT4760300	300
KT4760400	400
KT4760500	500
KT4760600	600
KT4760900	900
KT47601000	1000

Dragskaft 1/2"

Art.nr.	L mm
KT4768450	450

Förlängare 1/2" Wobbel

Art.nr.	L mm
KT476350	50
KT476375	75
KT4763125	125
KT4763150	150
KT4763250	250

Spärrskaft 1/2"

Art.nr.	L mm
KT4774450	450

Kulknut 1/2"

Art.nr.	L mm
KT4771	57,7

Hylssats 1/2" Kort 12-kant

Art.nr.	Antal	Dim.
KT4406M10	10st	10-19

Hylsa 1/2" Tum Kort 6-kant



Dessa finns även i 12-Kant **KT4405A**

Art.nr.	Dim.	Längd
KT4400A516	5/16"	36
KT4400A38	3/8"	37
KT4400A716	7/16"	37
KT4400A12	1/2"	37
KT4400A916	9/16"	37
KT4400A1932	19/32"	37
KT4400A58	5/8"	37
KT4400A2132	21/32"	37
KT4400A1116	11/16"	37
KT4400A34	3/4"	38
KT4400A2532	25/32"	38
KT4400A1316	13/16"	38
KT4400A78	7/8"	40
KT4400A1516	15/16"	42
KT4400A3132	31/32"	42
KT4400A1	1"	42
KT4400A1116	1 1/16"	43
KT4400A118	1 1/8"	43
KT4400A13160	1 3/16"	46
KT4400A114	1 1/4"	46
KT4400A15160	1 5/16"	47
KT4400A138	1 1/8"	47
KT4400A1716	1 7/16"	47
KT4400A112	1 1/2"	47

Hylsa 1/2" Lång 6-kant



Dessa finns även i 12-Kant **KT4305**

Art.nr.	Dim.	Längd
KT43008	8	77
KT43009	9	77
KT430010	10	77
KT430011	11	77
KT430012	12	77
KT430013	13	77
KT430014	14	77
KT430015	15	77
KT430016	16	77
KT430017	17	77
KT430018	18	77
KT430019	19	77
KT430020	20	77
KT430021	21	77
KT430022	22	77
KT430023	23	77
KT430024	24	77
KT430025	25	77
KT430026	26	77
KT430027	27	77
KT430028	28	77
KT430029	29	77
KT430030	30	77
KT430031	31	77
KT430032	32	77
KT430033	33	77
KT430034	34	77
KT430035	35	77
KT430036	36	77

Hylsa 1/2" Tum Lång 6-kant



Dessa finns även i 12-Kant **KT4305A**

Art.nr.	Dim.	Längd
KT4300A516	5/16"	77
KT4300A38	3/8"	77
KT4300A716	7/16"	77
KT4300A12	1/2"	77
KT4300A916	9/16"	77
KT4300A1932	19/32"	77
KT4300A58	5/8"	77
KT4300A2132	21/32"	77
KT4300A1116	11/16"	77
KT4300A34	3/4"	77
KT4300A2532	25/32"	77
KT4300A1316	13/16"	77
KT4300A78	7/8"	77
KT4300A1516	15/16"	77
KT4300A3132	31/32"	77
KT4300A1	1"	77
KT4300A1116	1 1/16"	77
KT4300A118	1 1/8"	77
KT4300A13160	1 3/16"	77
KT4300A114	1 1/4"	77
KT4300A15160	1 5/16"	77
KT4300A138	1 1/8"	77
KT4300A1716	1 7/16"	77
KT4300A112	1 1/2"	77
KT4300A112316	1 13/16"	77

Torxhylsa 1/2" kort



Art.nr.	Dim.	Längd
KT4425E8	E8	36
KT4425E10	E9	36
KT4425E11	E10	36
KT4425E12	E11	36
KT4425E14	E12	36
KT4425E16	E13	36
KT4425E18	E14	36
KT4425E20	E15	36
KT4425E22	E14	36
KT4425E24	E15	36

Torxhylsa 1/2" Lång



Art.nr.	Dim.	Längd
KT43258	E8	77
KT432510	E10	77
KT432511	E11	77
KT432512	E12	77
KT432514	E14	77
KT432516	E16	77
KT432518	E18	77
KT432520	E20	77
KT432524	E24	77



Tändstiftshylsa 1/2"



Art.nr.	Dim.	L mm
KT4300C16	16	70
KT4300C18	18	70
KT4300C208	20,8	70

Tändstiftshylsa 1/2" Ledad



Art.nr.	Dim.	L mm
KT434016	16	105
KT4340208	20,8	95

Tändstiftshylsa 1/2" Magnet



Art.nr.	Dim.	L mm
KT4305P16	19	65
KT4305P18	21	80
KT4305P206	22	80

Kråkfotssats 1/2" & 3/4" 12-kant



Art.nr.	Ansl.	Dim.
	1/2"	19, 21, 22, 24, 27, 30, 32
	3/4"	36, 41

MU571250

Kråkfot 1/2" & 3/4" 12-kant



Art.nr.	Ansl.	Dim.
MU571219	1/2"	19
MU571221	1/2"	21
MU571222	1/2"	22
MU571224	1/2"	24
MU571227	1/2"	27
MU571230	1/2"	30
MU571232	1/2"	32
MU571236	3/4"	36
MU571241	3/4"	41

Krafthylsor 1/2" Kort 6-kant



Dessa finns även i 12-Kant KT14405

Art.nr.	Ø mm	L mm
KT144008	8	38
KT144009	9	38
KT1440010	10	38
KT1440011	11	38
KT1440012	12	38
KT1440013	13	38
KT1440014	14	38
KT1440015	15	38
KT1440016	16	38
KT1440017	17	38
KT1440018	18	38
KT1440019	19	38
KT1440020	20	38
KT1440021	21	38
KT1440022	22	38
KT1440023	23	38
KT1440024	24	38
KT1440025	25	38
KT1440026	26	38
KT1440027	27	40
KT1440028	28	40
KT1440029	29	42
KT1440030	30	42
KT1440031	31	42
KT1440032	32	42
KT1440033	33	46
KT1440034	34	46
KT1440035	35	46
KT1440036	36	46
KT1440041	41	55

Krafthylsa 1/2" Tum Kort 6-kant



Art.nr.	Dim.	L mm
KT14400A516	5/16"	36
KT14400A38	3/8"	37
KT14400A716	7/16"	37
KT14400A12	1/2"	37
KT14400A916	9/16"	37
KT14400A58	5/8"	37
KT14400A1116	11/16"	37
KT14400A34	3/4"	38
KT14400A1316	13/16"	38
KT14400A78	7/8"	40
KT14400A1516	15/16"	42
KT14400A1	1"	42
KT14400A1116	1 1/16"	43
KT14400A118	1 1/8"	43
KT14400A13160	1 3/16"	46
KT14400A114	1 1/4"	46
KT14400A15160	1 5/16"	47
KT14400A138	1 1/8"	47
KT14400A112	1 1/2"	47

Krafthylsa 1/2" Kort



Art.nr.	Dim.	L mm
KT1446510	10	38
KT1446511	11	38
KT1446512	12	38
KT1446513	13	38
KT1446514	14	38
KT1446515	15	38
KT1446516	16	38
KT1446517	17	38
KT1446518	18	38
KT1446519	19	38
KT1446520	20	38
KT1446521	21	38
KT1446522	22	38
KT1446523	23	38
KT1446524	24	38
KT1446525	25	38
KT1446526	26	38
KT1446527	27	40

Krafthylsa 1/2" Lång 6-kant



Dessa finns även i 12-Kant **KT14305**
(8-24, 27, 28, 30, 32, 36)

Art.nr.	Dim.	L mm
KT143008	8	80
KT143009	9	80
KT1430010	10	80
KT1430011	11	80
KT1430012	12	80
KT1430013	13	80
KT1430014	14	80
KT1430015	15	80
KT1430016	16	80
KT1430017	17	80
KT1430018	18	80
KT1430019	19	80
KT1430020	20	80
KT1430021	21	80
KT1430022	22	85
KT1430023	23	85
KT1430024	24	85
KT1430025	25	85
KT1430026	26	85
KT1430027	27	85
KT1430028	28	85
KT1430029	29	85
KT1430030	30	85
KT1430031	31	85
KT1430032	32	85
KT1430033	33	85
KT1430034	34	85
KT1430035	35	85
KT1430036	36	85

Krafthylsats 1/2" 6-kant Extra tunn



Art.nr.	Antal	Dim.	L mm
KT14301171921	3st	17-19-21	80

Krafthylsa 1/2"..Tum Lång 12-kant



Art.nr.	Dim.	L mm
KT14300A516	5/16"	80
KT14300A38	3/8"	80
KT14300A716	7/16"	80
KT14300A12	1/2"	80
KT14300A916	9/16"	80
KT14300A58	5/8"	80
KT14300A1116	11/16"	80
KT14300A34	3/4"	80
KT14300A1316	13/16"	80
KT14300A78	7/8"	80
KT14300A1516	15/16"	80
KT14300A1	1"	80
KT14300A1116	1 1/16"	80
KT14300A118	1 1/8"	80
KT14300A13160	1 3/16"	85
KT14300A114	1 1/4"	85
KT14300A1716	1 7/16"	85
KT14300A112	1 1/2"	85

Krafthylsa 1/2" Torx



Art.nr.	Dim.	L mm
KT1442510	10	38
KT1442512	12	38
KT1442514	14	38
KT1442516	16	38
KT1442518	18	38
KT1442520	20	38
KT1442522	22	40
KT1442524	24	40

Förlängare 1/2" Kraft



Art.nr.	L mm
KT1476050	50
KT1476075	75
KT14760100	100
KT14760125	125
KT14760150	150
KT14760175	175
KT14760200	200
KT14760250	250

Kraftkulknut 1/2"



Art.nr.	L mm
KT14770	74

Förminskning & Förstoring 1/2"



KT14433



KT14466

Art.nr.	Typ	Ø tum	L mm
KT14433	Förminskning	1/2"x3/8"	36
KT14466	Förstoring	1/2"x3/4"	44

Momentstav 1/2"



Art.nr.	Dim.	L mm
KT141011495	14x95Nm	208
KT1410115110	15x110Nm	201
KT141011760	17x60Nm	216
KT141011775	17x75Nm	228
KT141011795	17x95Nm	214
KT1410117110	17x110Nm	204
KT1410117120	17x120Nm	200
KT141011960	19x60Nm	219
KT141011990	19x90Nm	259
KT1410119110	19x110Nm	214
KT1410119120	19x120Nm	203
KT1410119135	19x135Nm	206
KT1410119170	19x170Nm	190
KT1410121100	21x100Nm	214
KT1410121120	21x120Nm	203
KT1410122160	22x160Nm	209

Momentstav 1/2"



Art.nr.	Dim.	L mm
KT1411290	90Nm	208
KT1411295	95Nm	202
KT14112100	100Nm	196
KT14112110	110Nm	213
KT14112120	120Nm	201
KT14112130	130Nm	205
KT14112140	140Nm	205
KT14112150	150Nm	195
KT14112170	170Nm	195

Torxhylssats 1/2" Lång 5st



Art.nr.	Dim.	L mm
AST6004	E10, E12, E14, E16, E18	140

Insextapp 1/2"



Art.nr.	Dim.	L mm
KT4010M504	4	50
KT4010M505	5	50
KT4010M506	6	50
KT4010M507	7	50
KT4010M508	8	50
KT4010M5010	10	50
KT4010M5012	12	50
KT4010M5014	14	50
KT4010M5017	17	50
KT4010M5019	19	50

Insextapp 1/2" Lång



Art.nr.	Dim.	L mm
KT4010M1004	4	100
KT4010M1005	5	100
KT4010M1006	6	100
KT4010M1007	7	100
KT4010M1008	8	100
KT4010M10010	10	100
KT4010M10012	12	100
KT4010M10014	14	100
KT4010M10017	17	100
KT4010M10019	19	100

Insextapp 1/2"



Art.nr.	Dim.	L mm
KT4012434	4	43
KT4012435	5	43
KT4012436	6	43
KT4012437	7	43
KT4012438	8	43
KT4012439	9	43
KT40124310	10	43
KT40124311	11	43
KT40124312	12	43
KT40124313	13	43
KT40124314	14	43
KT40124315	15	43
KT40124316	16	43
KT40124317	17	43
KT40124318	18	43
KT40124319	19	43
KT40124320	20	43
KT40124321	21	43
KT40124322	22	43
KT40124323	23	43
KT40124324	24	43
KT40124327	27	43

Insextapp 1/2"



Art.nr.	Dim.	L mm
KT4012A43532	5/32"	43
KT4012A43316	3/16"	43
KT4012A43732	7/32"	43
KT4012A4314	1/4"	43
KT4012A43932	9/32"	43
KT4012A43516	5/16"	43
KT4012A431132	11/32"	43
KT4012A4338	3/8"	43
KT4012A43716	7/16"	43
KT4012A4312	1/2"	43
KT4012A43916	9/16"	43
KT4012A4358	5/8"	43
KT4012A4334	3/4"	43



XZN-tapp 1/2" Kort



Art.nr.	Dim.	L mm
KT4020M605	M5	60
KT4020M606	M6	60
KT4020M608	M8	60
KT4020M6010	M10	60
KT4020M6012	M12	60
KT4020M6014	M14	60
KT4020M6016	M16	60
KT4020M6018	M18	60

XZN-tapp 1/2" Lång



Art.nr.	Dim.	L mm
KT4020M1005	M5	100
KT4020M1006	M6	100
KT4020M1008	M8	100
KT4020M10010	M10	100
KT4020M10012	M12	100
KT4020M10014	M14	100
KT4020M10016	M16	100
KT4020M10018	M18	100

Torxtapp 1/2" Kort



Art.nr.	Dim.	L mm
KT4025T6020	T20	60
KT4025T6025	T25	60
KT4025T6027	T27	60
KT4025T6030	T30	60
KT4025T6040	T40	60
KT4025T6045	T45	60
KT4025T6050	T50	60
KT4025T6055	T55	60
KT4025T6060	T60	60
KT4025T6070	T70	60

Torxtapp 1/2" Lång



Art.nr.	Dim.	L mm
KT4025T14020	T20	140
KT4025T14025	T25	140
KT4025T14027	T27	140
KT4025T14030	T30	140
KT4025T14040	T40	140
KT4025T14045	T45	140
KT4025T14050	T50	140
KT4025T14055	T55	140
KT4025T14060	T60	140
KT4025T14070	T70	140

TORXplus (IP)		
	S (ref. mm)	S (ref. mm)
	8IP 2.29	30IP 5.49
	9IP 2.48	40IP 6.60
	10IP 2.72	45IP 7.77
	15IP 3.25	50IP 8.79
	20IP 3.84	55IP 11.16
	25IP 4.39	60IP 13.20
	27IP 4.95	

3/4"

TORX (T)		
	S (ref. mm)	S (ref. mm)
T 8	2.30	T45 7.77
T 9	2.48	T50 8.79
T10	2.72	T55 11.17
T15	3.26	T60 13.20
T20	3.84	T70 15.49
T25	4.40	T80 17.51
T27	4.96	T90 19.88
T30	5.49	T100 22.09
T40	6.60	

Ribetapp 1/2"



Art.nr.	Dim.	L mm
KT4027605	M5	60
KT4027606	M5	60
KT4027607	M7	60
KT4027608	M8	60
KT4027609	M9	60
KT40276010	M10	60
KT40276012	M12	60
KT40276013	M13	60
KT40276014	M14	60
KT40276016	M16	60

Spärrskaff 3/4"

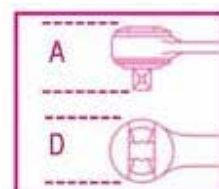

Art.nr.	L mm	A mm	Ø mm
BT9285	510	59	58

Torx Plustapp 1/2" Kort



Art.nr.	Dim.	L mm
KT4025IP6020	20	60
KT4025IP6025	25	60
KT4025IP6027	27	60
KT4025IP6030	30	60
KT4025IP6040	40	60
KT4025IP6045	45	60
KT4025IP6050	50	60
KT4025IP6055	55	60
KT4025IP6060	60	60

Ribetapp 1/2" Lång



Art.nr.	Dim.	L mm
KT40271005	M5	100
KT40271006	M6	100
KT40271007	M7	100
KT40271008	M8	100
KT40271009	M9	100
KT402710010	M10	100
KT4 02710012	M12	100
KT402710013	M13	100
KT402710014	M14	100
KT402710016	M16	100

Dragskraft 3/4" Ledat



Art.nr.	L mm
BT92836	545

Torx Plustappar 1/2" Lång



Art.nr.	Dim.	L mm
KT4025IP10040	40	100
KT4025IP10045	45	100
KT4025IP10050	50	100
KT4025IP10055	55	100
KT4025IP10060	60	100
KT4025IP10070	70	100

Ribe CV

	S (ref. mm)	W (ref. mm)
M 5	5	1.1
M 6	6	1.3
M 8	8	1.7
M10	10	2.2
M12	12	2.6
M14	14	3.1
M16	16	3.5

Dragskraft 3/4" T-handtag



Art.nr.	L mm	A mm
BT92842	450	62.5

Dragskraft 3/4"



Art.nr.	L mm
JEAK7312	1000

Förlängare 3/4"



Art.nr.	L mm
KT676075	75
KT6760100	100
KT6760125	125
KT6760150	150
KT6760200	200
KT6760300	300
KT6760400	400

Kulknut 3/4"



Art.nr.	L mm
KT6770	105

Förminskning & Förstoring 3/4"



KT6644



KT6688

Art.nr.	Typ	Ø tum	L mm
KT6644	Förminskning	3/4"x1/2"	47
KT6688	Förstoring	3/4"x1"	60

Hylsa 3/4" Kort 6-kant



Dessa finns även i 12-Kant **KT6405**

Art.nr.	Dim.	L mm
KT640017	17	50
KT640018	18	50
KT640019	19	50
KT640020	20	50
KT640021	21	50
KT640022	22	50
KT640023	23	50
KT640024	24	50
KT640025	25	50
KT640026	26	50
KT640027	27	53
KT640028	28	53
KT640029	29	55
KT640030	30	55
KT640031	31	57
KT640032	32	57
KT640033	33	57
KT640034	34	57
KT640035	35	59
KT640036	36	59
KT640037	37	59
KT640038	38	59
KT640039	39	59
KT640040	40	62
KT640041	41	62
KT640042	42	62
KT640043	43	62
KT640044	44	62
KT640045	45	68
KT640046	46	68
KT640047	47	68
KT640048	48	68
KT640050	50	68
KT640052	52	72
KT640054	54	72
KT640055	55	72
KT640056	56	72
KT640057	57	72
KT640058	58	72
KT640060	60	76
KT640063	63	76
KT640065	65	80
KT640070	70	84
KT640075	75	86
KT640080	80	90
KT640085	85	90

Hylsa 3/4" Tum Kort 6-kant



Art.nr.	Dim.	L mm
KT6400A1116	11/16"	50
KT6400A34	3/4"	50
KT6400A2532	25/32"	50
KT6400A1316	13/16"	50
KT6400A78	7/8"	50
KT6400A1516	15/16"	50
KT6400A3132	31/32"	50
KT6400A1	1"	50
KT6400A11160	1 1/16"	53
KT6400A118	1 1/8"	53
KT6400A13160	1 3/16"	55
KT6400A114	1 1/4"	57
KT6400A15160	1 5/16"	57
KT6400A138	1 3/8"	57
KT6400A1716	1 7/16"	59
KT6400A112	1 1/2"	59
KT6400A1916	1. 9/16"	59
KT6400A158	1. 5/8"	62
KT6400A11116	1. 11/16"	62
KT6400A134	1. 3/4"	62
KT6400A11316	1. 13/16"	68
KT6400A178	1. 7/8"	68
KT6400A11516	1. 15/16"	68
KT6400A2	2"	68
KT6400A2116	2. 1/16"	72
KT6400A218	2. 1/8"	72
KT6400A2316	2. 3/16"	72
KT6400A214	2. 1/4"	72
KT6400A2516	2. 5/16"	72
KT6400A238	2. 3/8"	76
KT6400A2716	2. 7/16"	76
KT6400A212	2. 1/2"	76
KT6400A2916	2. 9/16"	80
KT6400A258	2. 5/8"	80
KT6400A221116	2. 11/16"	80
KT6400A234	2. 3/4"	84
KT6400A21316	2. 13/16"	84
KT6400A278	2. 7/8"	84
KT6400A21516	2. 15/16"	86
KT6400A3	3"	86
KT6400A318	3. 1/8"	90

Hylsa 3/4" Lång 6-kant



Dessa finns även i 12-Kant **KT6305**

Art.nr.	Dim.	L mm
KT630017	17	90
KT630018	18	90
KT630019	19	90
KT630020	20	90
KT630021	21	90
KT630022	22	90
KT630023	23	90
KT630024	24	90
KT630025	25	90
KT630026	26	90
KT630027	27	90
KT630028	28	90
KT630029	29	90
KT630030	30	90
KT630031	31	90
KT630032	32	90
KT630033	33	90
KT630034	34	90
KT630035	35	90
KT630036	36	90
KT630038	38	90
KT630040	40	90
KT630041	41	90
KT630042	42	90
KT630044	44	90
KT630046	46	90
KT630048	48	90
KT630050	50	90
KT630052	52	100
KT630053	53	100
KT630054	54	100
KT630055	55	100
KT630056	56	100
KT630057	57	100
KT630058	58	100
KT630060	60	100
KT630063	63	100

Hylsa 3/4" Tum Lång 6-kant



Dessa finns även i 12-Kant **KT6305A**

Art.nr.	Dim.	L mm
KT6300A34	3/4"	50
KT6300A2532	25/32"	50
KT6300A1316	13/16"	50
KT6300A78	7/8"	50
KT6300A1516	15/16"	50
KT6300A1	1"	50
KT6300A1116	1 1/16"	53
KT6300A118	1 1/8"	53
KT6300A13160	1 3/16"	55
KT6300A114	1 1/4"	57
KT6300A15160	1 5/16"	57
KT6300A138	1 3/8"	57
KT6300A1716	1 7/16"	59
KT6300A112	1 1/2"	59
KT6300A1916	1. 9/16"	59
KT6300A158	1. 5/8"	62
KT6300A11116	1. 11/16"	62
KT6300A134	1. 3/4"	62
KT6300A11316	1. 13/16"	68
KT6300A2	2"	68
KT6300A2116	2. 1/16"	72
KT6300A218	2. 1/8"	72
KT6300A2316	2. 3/16"	72
KT6300A214	2. 1/4"	72
KT6300A2516	2. 5/16"	72
KT6300A238	2. 3/8"	76
KT6300A2716	2. 7/16"	76



Krafthylsa 3/4" Kort 6-kant



Dessa finns även som:
12-Kant
6-kant Extra tunna

KT16405
KT16401

Art.nr.	Dim.	L mm
KT1640017	17	50
KT1640018	18	50
KT1640019	19	50
KT1640020	20	50
KT1640021	21	50
KT1640022	22	50
KT1640023	23	50
KT1640024	24	50
KT1640025	25	50
KT1640026	26	50
KT1640027	27	50
KT1640028	28	50
KT1640029	29	53
KT1640030	30	53
KT1640031	31	53
KT1640032	32	53
KT1640033	33	55
KT1640034	34	55
KT1640035	35	55
KT1640036	36	55
KT1640037	37	55
KT1640038	38	57
KT1640039	39	57
KT1640040	40	57
KT1640041	41	57
KT1640042	42	57
KT1640043	43	62
KT1640044	44	62
KT1640045	45	62
KT1640046	46	62
KT1640047	47	62
KT1640048	48	62
KT1640050	50	62
KT1640052	52	62
KT1640054	54	62
KT1640055	55	62
KT1640056	56	62
KT1640057	57	65
KT1640058	58	65
KT1640059	59	65
KT1640060	60	65

Krafthylsa 3/4" Lång 6-kant



Dessa finns även som:
12-Kant
6-kant Extra tunna

KT16305
KT16301

Art.nr.	Dim.	L mm
KT1630017	17	100
KT1630018	18	100
KT1630019	19	100
KT1630020	20	100
KT1630021	21	100
KT1630022	22	100
KT1630023	23	100
KT1630024	24	100
KT1630025	25	100
KT1630026	26	100
KT1630027	27	100
KT1630028	28	100
KT1630029	29	100
KT1630030	30	100
KT1630031	31	100
KT1630032	32	100
KT1630033	33	100
KT1630034	34	100
KT1630035	35	100
KT1630036	36	100
KT1630037	37	100
KT1630038	38	100
KT1630040	40	100
KT1630041	41	100
KT1630042	42	100
KT1630046	46	100
KT1630050	50	100
KT1630055	55	100

Momentstav 3/4"



Art.nr.	Dim.	L mm
KT1610124180	24x180Nm	235
KT1610127450	27x450Nm	280
KT1610132600	32x600Nm	280
KT1610133600	32x600Nm	280

Insextapp 3/4"



Art.nr.	Dim.	L mm
KT601212	12	75
KT601214	14	75
KT601215	15	75
KT601216	16	75
KT601217	17	75
KT601218	18	75
KT601219	19	75
KT601220	20	75
KT601222	22	75
KT601224	24	75
KT601227	27	75
KT601230	30	75
KT601232	32	75
KT601236	36	75

Förlängare 3/4" Kraft



Art.nr.	L mm
KT16760150	155
KT16760175	175
KT16760200	200
KT16760250	250
KT16760330	330

Kulknut 3/4" Kraft



Art.nr.	L mm
KT16770	106

Förminskning & Förstoring 3/4" Kraft



Förminskning



Förstoring

Art.nr.	Typ	Ø tum	L mm
KT16644	Förminskning	3/4"x1/2"	52
KT16688	Förstoring	3/4"x1"	62

Hylsor 3/4" Extra långa 6-kant



Dessa finns även i 400 mm långa

Art.nr.	Dim.	L mm
KT1610224	24	270
KT1610227	27	270
KT1610230	30	270
KT1610232	32	270
KT1610233	33	270
KT1610236	36	270

Hylsa 3/4" Kraft Torx



Art.nr.	Dim.	L mm
KT1642518	E18	50
KT1642520	E20	50
KT1642522	E22	50
KT1642524	E24	50
KT1642526	E26	60
KT1642528	E28	60

Hylssats 3/4" 17st delar



Hylsor22,24,27,30,32,34,36,38,41,46,50,55
Spårskatft, dragskaft, Knut, 2st förlängare

BT928AC12

1"

Dragskaft 1"



Art.nr.	L mm
KT8785	550

Hylsa 1" Kort 6-kant



Dessa finns även i 12-Kant **KT8405**

Art.nr.	Dim.	L mm
KT840024	24	60
KT840026	26	60
KT840027	27	65
KT840030	30	65
KT840032	32	65
KT840033	33	65
KT840035	35	65
KT840036	36	65
KT840038	38	65
KT840040	40	65
KT840041	41	68
KT840042	42	68
KT840046	46	72
KT840050	50	72
KT840054	54	72
KT840055	55	77
KT840058	58	77
KT840060	60	82
KT840063	63	82
KT840065	65	86
KT840067	67	86
KT840068	68	86
KT840070	70	88
KT840071	71	88
KT840075	75	90
KT840080	80	95
KT840083	83	95
KT840085	85	95
KT840090	90	100
KT840095	95	100
KT840100	100	100

Dragskaft 1"



Art.nr.	L mm
JEAK7313	1000

Förlängare 1"



Art.nr.	D tum	L mm
KT8760200	44	200
KT8760400	44	400

Dragskaft 1" Ledat



Art.nr.	D mm.	L mm
KT8768	55	600

Förminskning 1"



Art.nr.	Typ	Ø tum	L mm
KT8866	Förminskning 1"x3/4"		60

Spärrskaft 1"

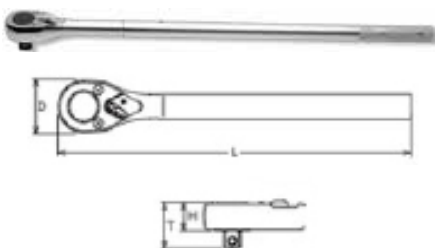

Art.nr.	L mm	D mm	T mm	H mm
KT8749	800	70	62,2	63,2

Kulknut 1"



Art.nr.	L mm
KT8770	143



Hylsa 1" Tum Kort 6-kant



Dessa finns även i 12-Kant **KT8405**

Art.nr.	Dim.	L mm
KT8400A1516	15/16"	60
KT8400A13160	1 3/16"	65
KT8400A114	1 1/4"	65
KT8400A15160	1 5/16"	65
KT8400A138	1 3/8"	65
KT8400A1716	1 7/16"	65
KT8400A112	1 1/2"	65
KT8400A1916	1. 9/16"	65
KT8400A158	1. 5/8"	68
KT8400A11116	1. 11/16"	68
KT8400A134	1. 3/4"	68
KT8400A11316	1. 13/16"	72
KT8400A178	1. 7/8"	72
KT8400A11516	1. 15/16"	72
KT8400A2	2"	72
KT8400A2116	2. 1/16"	72
KT8400A218	2. 1/8"	72
KT8400A2316	2. 3/16"	77
KT8400A214	2. 1/4"	77
KT8400A2516	2. 5/16"	77
KT8400A238	2. 3/8"	82
KT8400A2716	2. 7/16"	82
KT8400A212	2. 1/2"	82
KT8400A2916	2. 9/16"	86
KT8400A258	2. 5/8"	86
KT8400A221116	2. 11/16"	86
KT8400A234	2. 3/4"	88
KT8400A21316	2. 13/16"	88
KT8400A278	2. 7/8"	88
KT8400A21516	2. 15/16"	90
KT8400A3	3"	90
KT8400A318	3. 1/8"	95
KT8400A314	3. 1/4"	95
KT8400A338	3. 3/8"	95
KT8400A312	3. 1/2"	100
KT8400A334	3. 3/4"	100

Hylsa 1" Kraft Kort 6-kant



Dessa finns även i 12-Kant **KT18405**

Art.nr.	Dim.	L mm
KT1840017	17	57
KT1840018	18	57
KT1840019	19	57
KT1840021	21	57
KT1840022	22	57
KT1840023	23	57
KT1840024	24	57
KT1840025	25	57
KT1840026	26	57
KT1840027	27	57
KT1840028	28	57
KT1840029	29	57
KT1840030	30	62
KT1840031	31	62
KT1840032	32	62
KT1840033	33	62
KT1840034	34	62
KT1840035	35	62
KT1840036	36	62
KT1840037	37	62
KT1840038	38	66
KT1840040	40	66
KT1840041	41	66
KT1840042	42	66
KT1840043	43	68
KT1840044	44	68
KT1840045	45	68
KT1840046	46	70
KT1840047	47	70
KT1840048	48	70
KT1840050	50	70
KT1840052	52	75
KT1840054	54	75
KT1840055	55	75
KT1840056	56	75
KT1840058	58	75
KT1840060	60	75
KT1840062	62	75
KT1840063	63	75
KT1840065	65	75
KT1840067	67	75
KT1840068	68	75
KT1840070	70	75
KT1840075	75	80
KT1840080	80	85
KT1840085	85	90
KT1840090	90	95
KT1840095	55	100

Hylsa 1" Kraft Kort 6-kant



Dessa finns även som **extra tunn**

Art.nr.	Dim.	L mm
KT1830019	19	108
KT1830021	21	108
KT1830022	22	108
KT1830023	23	108
KT1830024	24	108
KT1830025	25	108
KT1830026	26	108
KT1830027	27	108
KT1830028	28	108
KT1830029	29	108
KT1830030	30	108
KT1830031	31	108
KT1830032	32	108
KT1830033	33	108
KT1830034	34	108
KT1830035	35	108
KT1830036	36	108
KT1830037	37	108
KT1830038	38	108
KT1830040	40	108
KT1830041	41	108
KT1830042	42	108
KT1830044	44	108
KT1830045	45	108
KT1830046	46	108
KT1830048	48	108
KT1830050	50	108
KT1830052	52	108
KT1830055	55	108
KT1830060	60	108
KT1830065	65	108
KT1830070	70	108
KT1830075	75	108
KT1830080	80	108
KT1830085	85	108
KT1830090	90	108
KT1830095	55	108

Insextapp 1"



Art.nr.	Dim.	L mm
KT801217	17	80
KT801219	19	80
KT801222	22	80
KT801224	24	80
KT801227	27	80
KT801230	30	80
KT801232	32	80
KT801236	36	80



Kulknut 1" Kraft



Art.nr.	L mm
KT18770	127

Förminskning 1" Kraft



Art.nr.	Typ	Ø tum	L mm
KT18866	Förminskning	1"x3/4"	65

Förlängare 1"

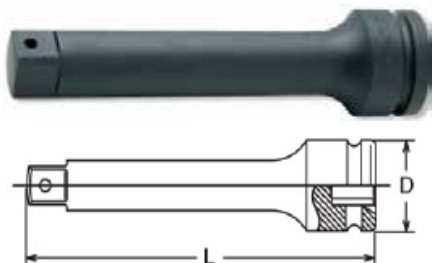

Art.nr.	D tum	L mm
KT18760175	54	175
KT18760200	54	200
KT18760250	54	250
KT18760330	54	330



Momentstav 1"



Art.nr.	Dim.	L mm
KT1810124350	24x350Nm	300
KT1810127350	27x350Nm	300
KT1810127450	27x450Nm	300
KT1810129400	29x400Nm	300
KT1810130500	30x500Nm	300
KT1810132450	32x450Nm	300
KT1810132550	32x550Nm	300
KT1810132600	32x600Nm	300
KT1810132700	32x700Nm	300
KT1810133550	33x550Nm	300
KT1810133600	33x600Nm	300
KT1810129400	36x600Nm	300



Krafthylsa 1" Extra Lång



Finns även som 400 mm lång

Art.nr.	Dim.	L mm
KT1810223	23	270
KT1810224	24	270
KT1810226	26	270
KT1810227	27	270
KT1810229	29	270
KT1810230	30	270
KT1810233	33	270
KT1810234	34	270
KT1810236	36	270
KT1810238	38	270



Tändstiftsnyckel Med T-skaft

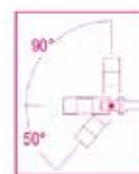

Art.nr.	Dim.	Ø mm	L mm
BT95914	14	18,8	483
BT95716	16	21,4	483
BT959208	20,8	27	527

Momentnyckel 1/4"

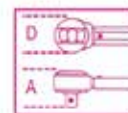

D mm	A mm	L mm	Vikt g
28	25	220	400

Art.nr.	Nm	Kgfm	lbf.in
BT6062	4÷20	0,4÷2	40÷180

Momentnyckel 3/8"

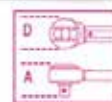

D mm	A mm	L mm	Vikt g
30	33	345	660

Art.nr.	Nm	Kgfm	lbf.in
BT60610	20÷100	2÷10	15÷80

Momentnyckel 1/2"

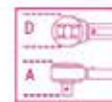

D mm	A mm	L mm	Vikt g
30	37	345	680

Art.nr.	Nm	Kgfm	lbf.in
BT60610X	20÷100	2÷10	15÷80

Momentnyckel digital



Ansl.	D mm	A mm	L mm	Vikt g
3/8"	30	37	413	1000

Nm	Kgfm	lbf.in
20÷100	2÷20	15÷80

Art.nr. _____

BT599DGT10

Ansl.	D mm	A mm	L mm	Vikt g
1/2"	40	43	520	2000

Nm	Kgfm	lbf.in
40÷200	4÷20	30÷150

Art.nr. _____

BT599DGT20

Ansl.	D mm	A mm	L mm	Vikt g
1/2"	40	43	539	2350

Nm	Kgfm	lbf.in
68÷340	6,8÷34	58÷280

Art.nr. _____

BT599DGT30



Momentnyckel 3/4"



Nm	D mm	A mm	L mm	Vikt g
100-500	70	55	945	5200

Art.nr. _____

BT67750

Nm	D mm	A mm	L mm	Vikt g
150-700	70	55	1140	6200

Art.nr. _____

BT67770

Nm	D mm	A mm	L mm	Vikt g
300-1000	70	55	1470	7500

Art.nr. _____

BT677100

Momentnyckel 1/2" Digital Med vinkelmätning



Nm	D mm	A mm	L mm	Vikt g
40-200	40	43	1470	520

Art.nr. _____

BT599DGT20

Vridvinkelmätare 1/2"



Art.nr. _____

JEVS530

Vridvinkelmätare 1/2" & 3/4" Digital



Behöver ingen fast referenspunkt att förankra till.
Försedd med summer och LED-indikatorer för att informera användaren att ställda vinkeln har nåtts.

Art.nr. _____

BT601

BT6011

Dim.

1/2"

3/4"

Vridvinkelmätare 1/2"



Används för noggrann åtdragning av bultar när vridmoments vinkel är nödvändig enligt tillverkarens specifikationer.

Art.nr. _____

CT8975

Vridvinkelskiva 1/2"

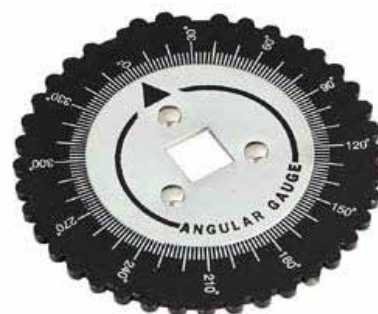

Art.nr. _____

JEVS531

Brytbladskniv Med 3st blad

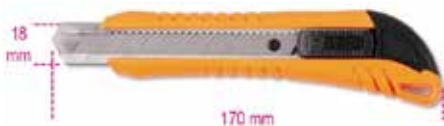

Art.nr.	Blad mm	L mm
BT1771	18	170

Bladkniv



Art.nr.	A	L1 mm	L mm
BT1777T	19	65	160

Skrapsats 3st



Art.nr.	B mm
JEAK523	32, 50, 32 (vinklad 20°)

Brytblad 10st



Blad till BT1771, BT1771BM, BT1771F.

Art.nr.	Blad mm	L mm
BT1771RL	18	110

Fällkniv



Art.nr.	A	L1 mm	L mm
BT1778	24	80	195

Skrapsats 3st



Art.nr.	B mm	L mm
JEAK524	13	50
	20	50
	16	100

Universalkniv



Art.nr.	A mm	L mm
BT1772B	18	165

Packningsskrapa



Skrapan är perfekt för att ta bort packningar, svart kol, underredsbehandling etc. Dessa skrapor kan återanvändas och slipas med en fil.

Art.nr.	B mm	L mm
ML7243 (vinklad)	24	205
ML7039	24	255
ML7040	37	280

Skrapsats 4st I komposit



Art.nr.	B mm	L mm
JEAK5251	19	270
	22	270
	26	270
	38	270

Knivblad 10st

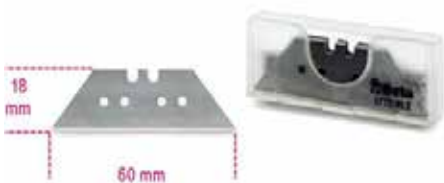

Art.nr.	Blad mm	L mm
BT1772RL2	18	50

Skrapa



Passande knivblad **BT1772RL2**

Art.nr.	L1 mm	L mm
BT1774	60	165

Glasskrapa Inkl. 5 st blad



Art.nr.	L mm
JEAK867	100

Skrapblad 5 pack



Art.nr.	Antal
JEAK8671	5

Bladmått

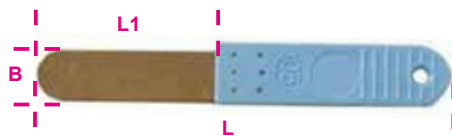

B mm	L1 mm	L mm
13	45	105

Art.nr.	Ø mm	Färg
ML20105	0,05	Ljusblå
ML20108	0,08	Mörkgrön
ML20110	0,10	Lila
ML20115	0,15	Vit
ML20120	0,20	Mörkblå
ML20125	0,25	Grå
ML20130	0,30	Gul
ML20135	0,35	Ljusgrön
ML20140	0,40	Röd
ML20145	0,45	Svart
ML20150	0,50	Beige
ML20155	0,55	Rödbrun
ML20160	0,60	Mörkbrun
ML20170	0,70	Orange

Skjutmått 200 mm



Hög kvalitet, skjutmått i härdat och rostfritt stål. Dubbel läsning, med mikro-thumb justering. Metrisk och Imperial skalor graderade i 0,02 mm och 0,001". Levereras i förvaringsväska.

Art.nr.
JEAK9622

Bladmått



Art.nr.	Antal/blad	S
BT17088	8	0,05-0,50
BT170813	13	0,05-1,00
BT170820	20	0,05-1,00

Skjutmått Bromstrumma



Skjutmått för att mäta insidan av bromstrummor.

Gradering: 0,02 mm
Käkar: 94 mm
Mätområde: inne 40-340 mm, utanför 0-300 mm
Vikt: 710 g

Art.nr.
BV030230

Bladmåttsats 14st Färgkodade



Ø mm
0,05 - 0,08 - 0,10 - 0,15 - 0,20 - 0,25 - 0,30
0,35 - 0,40 - 0,45 - 0,50 - 0,55 - 0,60 - 0,70

Art.nr.	B mm	L1 mm	L mm
ML2010570	13	45	105

Skjutmått

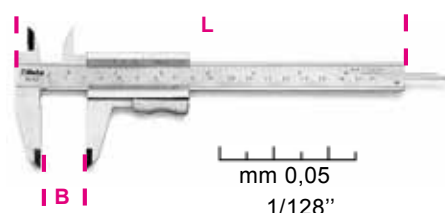

Art.nr.	B max/mm	L mm
BT1650	150	235

Skjutmått Bromskivor



Digitalt skjutmått för mätning av bromsskivor på bilar. Med "hold"-knapp.

Mätområde: 0-60 mm
Upplösning: 0,1 mm
Käkar: 52 mm
Vikt: 500 g

Art.nr.
BV030265



Skjutmått Digitalt



Mätområde 0-150 mm.
Manuell strömförsörjning på & av.
Metrisk & tum konvertering.
Automatisk avstängning med "hold" knapp.

Art.nr.
BV030610

Mikrometer



Art.nr.	A mm
BT165825	0-25
BT165850	25-50
BT165875	50-75
BT1658100	575-100

Vippindikator



Justerbar indikatorlocka läser till 0,01 mm

Art.nr.
BT1662AN

Indikatorstativ



Med finjustering
Vridomkopplare för magnetaktivering.
Magnet: 50 × 60 × 55 mm
Vidhäftnings kapacitet 80 kg
Prismaguide, gänga M8
Vertikalstång Ø 16 mm, längd 225 mm
Horisontellstång: Ø 12 mm, längd 180 mm
Dialt monteringshål Ø 8 mm
Material: stöttålig bakelit knapp

Art.nr.
E1565

Stålskala



Art.nr.	L mm
BT1683300	300
BT1683500	500
BT16831000	1000
BT16831500	1500
BT16832000	2000

Mikrometerhållare



Tillverkad av gjutjärn
Klämma med gummi-inläggningar.
90 grader.

Art.nr.
BT1658SP1

Ritsnål



Art.nr.	Ø mm	L mm
BT1688	2	250

Indikatorlocka



Passar till indikatorstativ **E1565**

Mätområde: 10 mm
Läsning: 0,01 mm
Vatten- och lätt stötsäker, med rostfritt metallhölje. Levereras i en plastlåda.

Art.nr.
E1555

Måttband



Art.nr.	L mm	S mm
BT1691BG3	3	19
BT1691BG5	5	25
BT1691BG8	8	25
BT1691BG10	10	25

Ritsnål



Art.nr.	Ø mm	L mm
BT1688A	4	200



Stålskala



Art.nr.	L mm
BT1682150	150
BT1682200	200
BT1682250	250
BT1682300	300
BT1682500	500
BT16821000	1000

Ritsspets Wolframpets



Med clip & magnet

Art.nr.	Ø mm	L mm
ML1830	8	137

Syl



Art.nr.	Ø mm	L1 mm	L mm
BT1716R	6	100	215

Skruvmejselsats 5st & 3st



Dim mm
2,5X50 - 3X75 - 4X100 - 5,5X125 - 6,5X150
PH0x60 - PH1x80 - PH2x100

Art.nr.
BT1263D8

Skruvmejselsats 4st & 3st



Dim mm
5,5X100 - 6,5X125 - 8X100 - 10X200
PH1x100 - PH2x100 - PH3x150

Art.nr.
BT1243D7

Skruvmejselsats 4st & 4st



Dim mm
3X75 - 4X125 - 5,5X150 - 6,5X150
PH0x60 - PH1x80 - PH2x100 - PH3x150

Art.nr.
BT1203D8

Skruvmejsel Spår



Art.nr. SxAxL mm L1 mm Ø mm

BT12601	0,4x2,5x50	150	2,5
BT12602	0,4x2,5x75	175	2,5
BT12603	0,5x3x75	175	3,0
BT12604	0,5x3x100	200	3,0
BT12605	0,6x3,5x75	175	3,5
BT12606	0,6x3,5x100	200	3,5
BT12607	0,8x4x100	208	4,0
BT12608	0,8x4x125	233	4,0
BT12609	0,8x4x150	258	4,0
BT126010	1x5,5x100	208	5,0
BT126011	1x5,5x125	233	5,0
BT126012	1x5,5x150	258	5,0
BT126013	1,2x6,5x100	219	6,0
BT126014	1,2x6,5x125	244	6,0
BT126015	1,2x6,5x150	269	6,0
BT126016	1,2x8x150	277	8,0
BT126017	1,2x8x200	327	8,0
BT126018	1,6x10x200	327	9,5
BT126019	2x12x250	377	10

Skruvmejsel Spår



Art.nr. SxAxL mm L1 mm Ø mm

BT1260N1	0,8x4x30	87	4,0
BT1260N2	1,2x6,5x30	87	6,0

Skruvmejsel PH



Art.nr. PHxDxL mm L1 mm

BT1262N1	1x4,5x30	87
BT1262N2	2x6x30	87

Skruvmejsel PH



Skruvmejsel PZ



Art.nr. PZ L mm L1 mm

BT1269PZ0	0	100	160
BT1269PZ1	1	108	188
BT1269PZ2	2	119	219
BT1269PZ3	3	127	277
BT1269PZ4	4	127	327

Skruvmejsel PH



Art.nr. PHxDxL mm L1 mm

BT1262L0	0x3x300	400
BT1262L1	1x4,5x400	508
BT1262L2	2x6x400	519

Skruvmejsel Spår

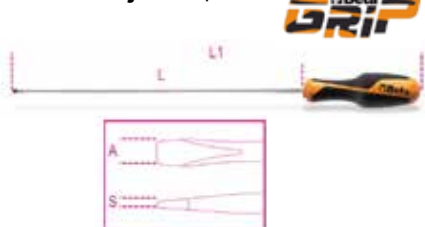

Art.nr.	SxAxL mm	L1 mm
BT1264L1	0,5x2,5x200	300
BT1264L2	0,6x3x300	400
BT1264L3	0,8x4x400	508
BT1264L4	1x5x400	508
BT1264L5	1,2x6,5x400	519

Skruvmejsel Insex



Art.nr.	Ø mm	L mm	L1 mm
BT1265ES1	1,5	100	200
BT1265ES2	2	100	200
BT1265ES3	2,5	100	200
BT1265ES4	3	100	200
BT1265ES5	4	100	208
BT1265ES6	5	100	219
BT1265ES7	6	125	244
BT1265ES8	8	150	277

Skruvmejsel Insex med kula



Art.nr.	Ø mm	L mm	L1 mm
BT1266BP1	2	100	200
BT1266BP2	2,5	100	200
BT1266BP3	3	125	225
BT1266BP4	4	125	233
BT1266BP5	5	120	239
BT1266BP6	6	140	259
BT1266BP7	8	160	287
BT1266BP8	10	160	287

Skruvmejsel Torx



Art.nr.	T	L mm	L1 mm	Ø mm
BT1267TX5	T5	50	150	3
BT1267TX6	T6	50	150	3
BT1267TX7	T7	50	150	3
BT1267TX8	T8	60	160	3
BT1267TX9	T9	60	167	4
BT1267TX10	T10	80	188	4
BT1267TX15	T15	80	188	4
BT1267TX20	T20	100	208	4,5
BT1267TX25	T25	100	208	5
BT1267TX27	T27	115	234	6
BT1267TX30	T30	115	234	6
BT1267TX40	T40	130	257	7
BT1267TX45	T45	130	257	8

Skruvmejsel Torx med hål



Art.nr.	T	L mm	L1 mm	Ø
BT1268RTX9	T9	60	167	4
BT1268RTX10	T10	80	188	4
BT1268RTX15	T15	80	188	4
BT1268RTX20	T20	100	208	4,5
BT1268RTX25	T25	100	208	5
BT1268RTX27	T27	115	234	6
BT1268RTX30	T30	115	234	6
BT1268RTX40	T40	130	257	7

Skruvmejsel Spår



Art.nr.	SxAxL mm	L1 mm
BT12411	1x5,5x100	202
BT12412	1,2x6,5x125	240
BT12413	1,2x8x150	248
BT12414	1,6x10x200	325

Instrumentmejsel Spår



Art.nr.	SxD mm	L1 mm
BT1257LP1	0,25x1,2	50
BT1257LP2	0,23x1,5	50
BT1257LP3	0,3x1,8	50
BT1257LP4	0,4x2	75
BT1257LP5	0,4x2,5	75
BT1257LP6	0,5x3	75
BT1257LP7	0,6x3,5	75
BT1257LP8	0,8x4	75

Instrumentmejsel Spår



Art.nr.	PH	L
BT1257PH00	00	75
BT1257PH0	0	75
BT1257PH1	1	75



Instrumentmejsel Torx



Art.nr.	T	L mm
BT1257TX5	T5	75
BT1257TX6	T6	75
BT1257TX7	T7	75
BT1257TX8	T8	75
BT1257TX9	T9	75
BT1257TX10	T10	75
BT1257TX15	T15	75
BT1257TX20	T20	75

Instrumentmejsel Insex



Art.nr.	Ø mm	L mm
BT1257ES1	0,9	75
BT1257ES2	1,3	75
BT1257ES3	1,5	75
BT1257ES4	2,0	75
BT1257ES5	2,5	75
BT1257ES6	3,0	75

Skruvmejsel Super stark Spår

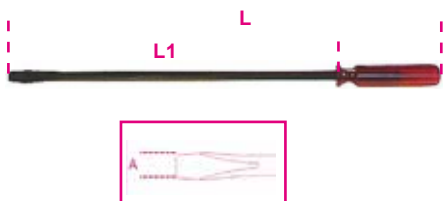

Art.nr.	A mm	L1 mm	L mm
ML6019	16	485	640













Slagskruvmejsel 1/2"



Art.nr.	L mm
BT1295	130

Slagskruvmejselsats 1/2"



		1,2x6,5 - 1,6 - 10 mm
		PH2 - PH3
		PZ2 - PZ3
		5 - 6 mm
		T27 - T30 - T40 - T45
		T50 - T55

Art.nr.	
BT1295C14	



Skruvstartare Spår



Kropp av aluminium, med klipp och magnet.

Art.nr.	Dim. mm	L mm	Ø mm
MLD2	5 - 10	145	7

Skruvstartare Torx, Insex, PH, PZ



Kropp av aluminium, med klipp och magnet.

Art.nr.	Dim. mm	L mm	Ø mm
MLF2	PH-PZ-TX-HEX	135	9

Skruvstartare PH



Kropp av aluminium, med klipp och magnet.

Art.nr.	Dim. mm	L mm	Ø mm
MLPD10	PH 2 - 3	145	7

Röravskärare



Art.nr.	Ø mm	L mm
BT332	3 - 16	59

Röravskärare



Art.nr.	Ø mm	L mm
BT334	3 - 30	150

Röravskärare



Art.nr.	Ø mm	L mm
BT3302	10 - 60	380

Gradverktyg



Art.nr.	Ø mm	L mm
BT345	3 - 42	58

Inspektionsspegel Teleskopisk



Med klipps.

Justerbar i 360°, åt alla håll.
Spegel med klarglas, och bakstycke av metall.

Art.nr.	Ø mm	L mm
MLA2T	22	155 - 475

Röravskärare



Art.nr.	Ø mm	L mm
BT339A	50 - 127	345

Plockverktyg



Art.nr.	L mm	L1 mm
BT1687S4	153	80

Spegel



Spegel med klarglas, och bakstycke av metall.

Art.nr.	Ø mm
MLB2HD	26x50

Skärtrissa Till BT332 & BT334



Art.nr.	Modell	L mm
BT334R	BT332 & BT334	18,5
	Koppar och mjuk lättmetall	
BT334RI	BT332 & BT334	18,5
	Rostfria stålrör	

Instrumenthakar Sats 4st



Kropp av aluminium, med magnet.

Art.nr.	L mm
MLH4W	165

Inspektionsspegel Teleskopisk



Med klipps.

Justerbar i 360°, åt alla håll.
Spegel med klarglas, och bakstycke av metall.

Art.nr.	Ø mm	L mm
MLB2T	26x50	185 - 505

Skärtrissa BT336 & BT338



Art.nr.	Modell	L mm
BT338R	BT336 & BT338	18,5
	Koppar och mjuk lättmetall	
BT338RP	BT336 & BT338	23,5
	Plaströr	

Gripklo Flexibel



Flexibel axel och 4 gripande klor, för hämtning av objekt.

Art.nr.	L mm
ML16	600
ML17	340

Inspektionsspegel Teleskopisk



Justerbar i 360°, åt alla håll.
Spegel med klarglas, och bakstycke av metall.

Art.nr.	Ø mm	L mm
MLC2	56	254 - 375
MLS2	81	280 - 395

Spegel

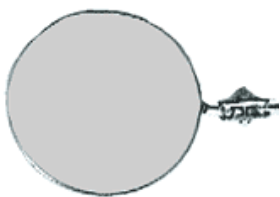

Spegel med klarglas, och bakstycke av metall.

Art.nr. _____ Ø mm

MLE2HD 56

Inspektionsspegel Teleskopisk



Glidsäkert grepp.

Justerbar i 360°, åt alla håll.
Spegel med klarglas, och bakstycke av metall.

Art.nr. _____ Ø mm L mm

MLHTS2 81 265 - 740

Magnetplockare Teleskopisk



Chromad kropp med glidsäkert hölje.

Med avtagbart hölje, vilken riktar magnetens kraft till fronten av magnethuvudet, vilket gör att magneten inte drar sidledes.
Magnet med hölje: 12 mm
Magnet utan hölje: 8 mm

Art.nr. _____ Lyftkraft g L mm

MLHT5 1350 140-645

Inspektionsspegel



Med klipps.

Justerbar i 360°, åt alla håll.
Spegel med klarglas, och bakstycke av metall.

Art.nr. _____ Ø mm L mm

MLE2M 32 200

Inspektionsspegel Teleskopisk



Justerbar i 360°, åt alla håll.
Spegel med klarglas, och bakstycke av metall.

Art.nr. _____ Ø mm L mm

MLK2 52x87 285-400

Magnetkub



Kuben magnetiserar eller avmagnetiserar verktyg som t ex. skruvmejslar mm.
Öppning Ø 9 mm.

Art.nr. _____ Ø mm

ML5 9

Inspektionsspegel Teleskopisk



Med klipps.

Justerbar i 360°, åt alla håll.
Spegel med klarglas, och bakstycke av metall.

Art.nr. _____ Ø mm L mm

MLE2T 32 165 - 485

Magnetplockare Teleskopisk



Kromskaft med klipps.

Art.nr. Magn. Ø mm Lyftkraft g L mm

ML19X 11 1600 145-650

MAGNETSTAV Flexibel



Fjädrande skaft

Art.nr. Magn. Ø mm Lyftkraft g L mm

ML3F 8 700 555

Inspektionsspegel Teleskopisk



Glidsäkert grepp.

Justerbar i 360°, åt alla håll.
Spegel med klarglas, och bakstycke av metall.

Art.nr. _____ Ø mm L mm

MLHTC2 56 245 - 920

Magnetplockare Flexibel



Böjbar, håller positionen

Art.nr. Magn. Ø mm Lyftkraft g L mm

ML14X 8 680 540

MAGNETSTAV Flexibel



Böjbar, håller positionen

Art.nr. Magn. Ø mm Lyftkraft g L mm

ML164 14 2250 540

MAGNETSTAV Flexibel



Indragbar magnet

Art.nr.	Magn. Ø mm	Lyftkraft g	L mm
ML18X	11	680	560

Sidavbitartång



Art.nr.	L1 mm	L mm
ML447	26	197

Flackstång

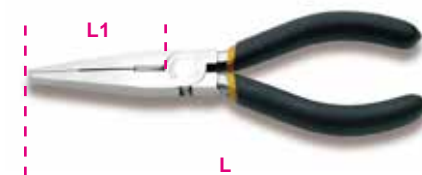

Art.nr.	mm	L1 mm	L mm
BT1162160	1,6	58	160
BT1162200	1,6	86	200

MAGNETSTAV Flexibel



Böjbar, håller positionen

Art.nr.	Magn. Ø mm	Lyftkraft g	L mm
BT17121	7,5	500	420

Sidavbitartång



Art.nr.	mm	L1 mm	L mm
BT1094V200	2,5	23	200

Plattstång Vinklad

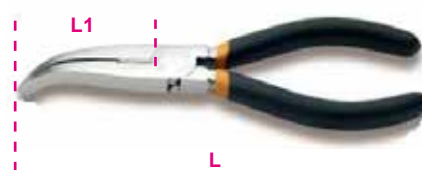

Art.nr.	mm	L1 mm	L mm
BT1164160	1,6	54	160
BT1164200	1,6	76	200

Sidavbitartång



Art.nr.	mm	L1 mm	L mm
BT1082BM140	1,4	20	140
BT1082BM160	1,6	22	160
BT1082BM180	1,8	25	180
BT1082BM200	2,0	28	200

Kombinationstång



Art.nr.	mm	L1 mm	L mm
BT1150160	1,6	37	160
BT1150180	1,8	41	180
BT1150200	2,0	45	200
BT1150220	2,0	50	220

Spetstång



Art.nr.	mm	L1 mm	L mm
BT1166BM160	1,6	56	160
BT1166BM200	1,6	76	200

Sidavbitartång



Art.nr.	mm	L1 mm	L mm
BT1084140	1,4	20	140
BT1084160	1,6	22	160
BT1084180	1,8	25	180
BT1084200	2,0	28	200

Hovstång



Art.nr.	L1 mm	L mm
BT1096160	21	160
BT1096200	23	200
BT1096250	30	250

Spetstång



Art.nr.	mm	L1 mm	L mm
BT1166N160	1,6	56	160
BT1166N200	1,6	76	200

Spetstång Vinklad



Art.nr.	mm	L1 mm	L mm
BT1168N160	1,6	54	160
BT1168N200	1,6	76	200

Plattång Special

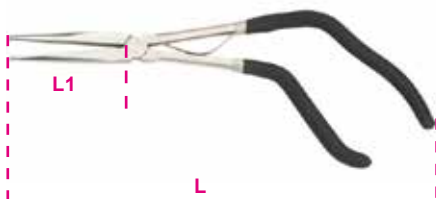

Art.nr.	L1 mm	L mm
MU748310	80	300

Tång Dubbelled Vinklad - Spets

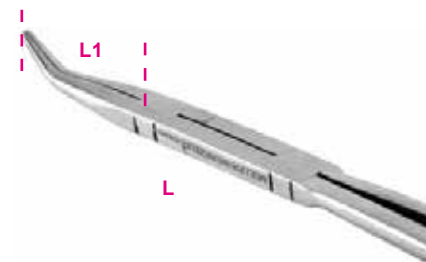

Art.nr.	L1 mm	L mm
MU748203	60	325

Spetstång Lång



Art.nr.	L1 mm	L mm
BT1009LB	73	273

Spetstänger Dubbelled



Art.nr.	Tång nr.	L1 mm	L mm
MU748202	1	70	340
MU748203	2	60	325
MU748201	3	33	298

MU7482003

Elektroniktång



Art.nr.	mm	L1 mm	L mm
BT1182BM	1	11	120

Spetstång Lång Rak



Art.nr.	L1 mm	L mm
BT1009LA	80	283

Tång Dubbelled Flat

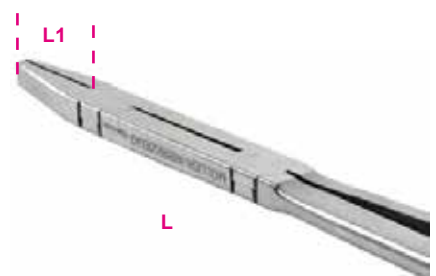

Art.nr.	L1 mm	L mm
MU748201	33	298

Elektroniktång



Art.nr.	mm	L1 mm	L mm
BT1184BM120	1	11	120
BT1184BM130	1,25	13	130

Spetstång Lång Vinklad 90°



Art.nr.	L1 mm	L mm
BT1009LC	45	253

Tång Dubbelled Spets



Art.nr.	L1 mm	L mm
MU748202	70	340

Spetstång



Art.nr.	L1 mm	L mm
BT1177BM	38	140

Spetstång



Art.nr.	L1 mm	L mm
BT1178BM	37	140

Bultsax



Art.nr.	mm	L mm
BT1100300	5	300
BT1100350	6	350
BT1100450	7	450
BT1100600	9	600
BT1100750	11	750
BT1100900	12	900

Kabelsax



Art.nr.	mm	L1 mm	L mm
ML911	35,5	35,5	241

Elektroniktång



Art.nr.	L1 mm	L mm
BT1178BMP	36,5	140

Kabelskalare



Automatisk justering av kabel diametern.
För kablar mellan 0,2 - 6,0 mm
Längd inställning från 5 till 12 mm.
Avbitare upp till 2mm.

Art.nr.
BT1094

Kabelsax



Art.nr.	mm	L mm
BT1134	35	250

Vajersax



Art.nr.	mm	L mm
BT1136	5 Kabel	165
	4 Mjuk stålult	

Skaltång



Självjusterande skaltång för vajer.
Längd 175mm
0,2 ÷ 6
28÷17 AWG

Art.nr.
BT1149F

Kabelsax



Art.nr.	mm	L mm
BT1133	30	600

Bultsax



Art.nr.	mm	L mm
BT1102	4	230

Kabelsax



Art.nr.	mm	L mm
BT1132170	10	170
BT1132230	17	230

Kabelskotång Isolerad Kabelsko



Art.nr.	mm	L mm
BT1602	0,75 - 6	200

Kabelskotång Oisolerad Kabelsko



Art.nr.	mm	L mm
BT1603	1,25 - 5,5	200

Kabelskotång Oisolerad Kabelsko



Art.nr.	mm	L mm
BT1605	0,5 - 6	215

Kabelskotång Cylindrisk



Art.nr.	mm	L mm
BT1606	0,5 - 6	220

Kabelskotång Isolerad & Oisolerad

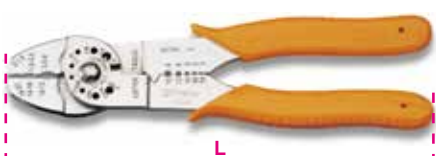

Art.nr.	mm	L mm
BT1602A	0 - 8	220

Isolerad kabelsko



Art.nr.	mm	L mm
BT1603A	0 - 8	220

Oisolerad kabelsko



Art.nr.	mm	L mm
BT1603B	0 - 8	220

Oisolerad kabelsko



Kabelskotång Isolerad Kabelsko



Art.nr.	mm	L mm
BT1608	0,5 - 6	230

Kabelskotång



Art.nr.	mm	L mm
BT1609B	10 - 120	600

Kabelskotång



Art.nr.	mm	L mm
BT1609	0,5 - 2,5	205

Kabelskopress



För kontaktpressning, som uppnås med ett kraftigt hammarslag. Lämplig för bl a batterikabelsko.

Art.nr.	mm
BV12300	4 - 90

Kabelskotång Isolerad Kabelsko



Art.nr.	mm	L mm
BT1604	0,5 - 6	215

Kabeltång



6,48 - 5,41 - 1,69

Art.nr.	L mm
BT1607	220

Kabeltång

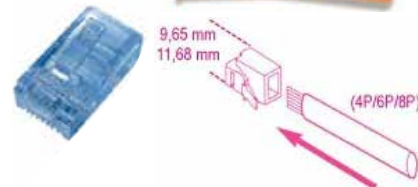

Art.nr.	mm	L mm
BT1601	RJ11, RJ12, RJ15	190

Låsringstång Rak



Art.nr.	L mm	Ø mm
BT10321409	140x0,9	8 - 12
BT1032140	140x1,3	12 - 25
BT1032180	180	19 - 60
BT1032225	225	40 - 100
BT1032300	300	85 - 200

Låsringstång Vinklad 45°



Art.nr.	L mm	Ø mm
BT103714009	140x0,9	3 - 10
BT1037140	140x1,3	10 - 25
BT1037175	175	19 - 60
BT1037225	225	40 - 100

Låsringstång Utvärdig & Invärdig



Vändbar låsringstång för både utvärdig och invärdiga ringar.

Låsringstång Vinklad 45°



Art.nr.	L mm	Ø mm
BT1033140	140x0,9	8 - 12
BT103314013	140x1,3	12 - 25
BT1033180	180	19 - 60
BT1033225	225	40 - 100

Låsringstång Vinklad 90°



Art.nr.	L mm	Ø mm
BT103813509	135x0,9	3 - 10
BT1038135	135x1,3	10 - 25
BT1038175	175	19 - 60
BT1038220	220	40 - 100
BT1038300	300	85 - 200

Art.nr.	Typ	Spets		L mm
		Ø mm	Ø mm	
ML12R	Rak	0,9	8-18	150
ML1245R	45°	0,9	8-18	150
ML1290R	90°	0,9	8-18	145
ML32R	Rak	1,2	12-25	155
ML3245R	45°	1,2	12-25	155
ML3290R	90°	1,2	12-25	150
ML34R	Rak	1,8	18-48	195
ML3445R	45°	1,8	18-48	195
ML3490R	90°	1,8	18-48	190
ML56R	Rak	2,3	31-82	235
ML5645R	45°	2,3	31-82	235
ML5690R	90°	2,3	31-82	230

Låsringstång Vinklad 90°



Art.nr.	L mm	Ø mm
BT1034130	130x0,9	8 - 12
BT103413013	130x1,3	12 - 25
BT1034170	170	19 - 60
BT1034210	210	40 - 100
BT1034290	290	85 - 200

Låsringstångsats



BT1031S4

Låsringstångsats 12st Utv- & Invärdig



Art.nr.
ML12R, ML1245R, ML1290R, ML32R, ML3245R, ML3290R, ML34R, ML3445R, 3490R, ML56R, ML5645R, ML5690R.
ML4312R

Låsringstång Rak



Art.nr.	L mm	Ø mm
BT103614009	140x0,9	3 - 10
BT1036140	140x1,3	10 - 25
BT1036175	175	19 - 60
BT1036225	225	40 - 100
BT1036300	300	85 - 200

Låsringstång Lång nos Vinklad 90°



Art.nr.	L mm	Ø mm
BT1034L	192	40 - 100

Låsringstångsats Heavy Duty



Art.nr.	Typ	Spets		L mm
		Ø mm	Ø mm	
CT8870	Rak	0,9	0-85	400
	Vinklad 45°	0,9	0-85	400
	Vinklad 90°	0,9	0-85	400

Låsringstång



Art.nr.	L mm	Ø mm
BT1458	200	30 - 100

Plåtsax

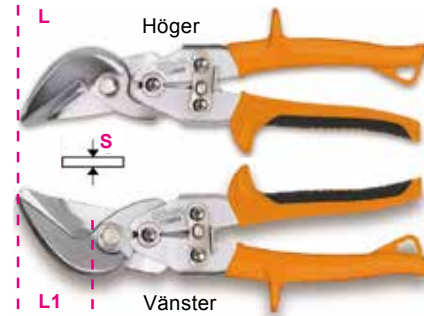

Inox = Rostfrittstål

Art.nr.	Typ	Inox		
		S mm	L1 mm	L mm
BT1125BM	Höger	1	35	250
BT1126BM	Vänster	1	35	250

Bänkplåtsax



Art.nr.	Stål	Rund	Max
	Plåt mm	Stång mm	Skär mm
JE3S4R	4	10	120

Låsringstång



Art.nr.	L mm
CT8840	230

Plåtsax



Fe = Normal metall
Inox = Rostfrittstål

Art.nr.	Fe	Inox	L1 mm	L mm
	S mm	S mm		
BT1118	1	0,8	42	310

Polygrip

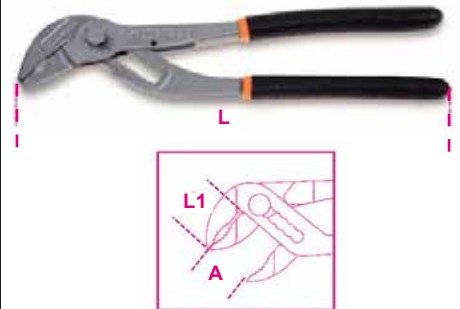

Art.nr.	A max mm	L1 mm	L mm
BT1047240	36	35	240
BT1047300	50	48	300

Låsringstång



Art.nr.	L mm	Ø mm
SW12210000	310	- 40mm

Nibblingsax



Fe = Normal metall

Art.nr.	Fe	L mm
	S mm	
BT1120	1,2	280

Polygrip

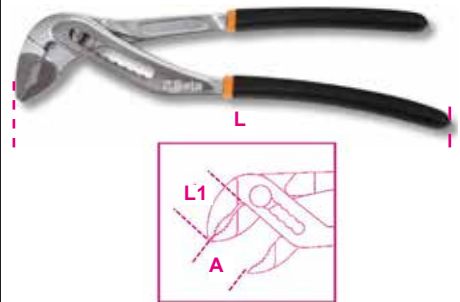

Art.nr.	A max mm	L1 mm	L mm
BT1048175	30	29	175
BT1048250	48	39	250
BT1048300	56	47	300

Plåtsax

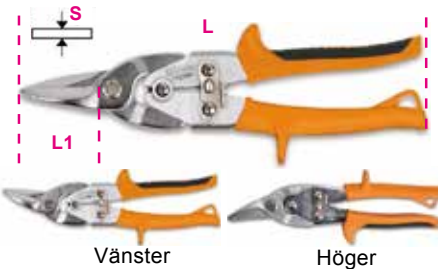

Inox = Rostfrittstål

Art.nr.	Typ	Inox		
		S mm	L1 mm	L mm
BT1122BM	Rak	1	40	340
BT1123BM	Höger	1	40	340
BT1124BM	Vänster	1	40	340

Bänkplåtsax



Art.nr.	Stålplåt
	S mm
JEDC16	1,3

Polygrip Självläsande



Art.nr.	A max mm	L mm
BVMP7	35	175
BVMP10	50	250
BVMP12	60	300

Polygrip Raka Käftar

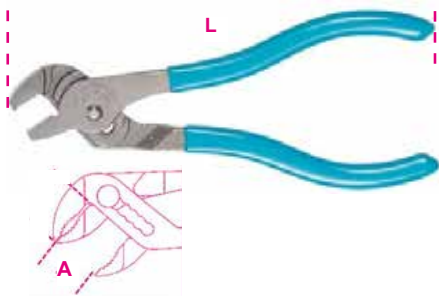

Art.nr.	A max mm	L mm
ML424	13	114

Polygrip Papegojkäftar

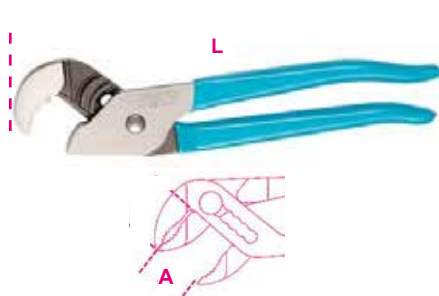

Art.nr.	A max mm	L mm
ML410	29	240
ML414	51	350

Popnitset



Art.nr.	Ø mm	L mm	Antal
	3,0	6	200
	3,2	8	200
	4,0	10	100
	4,0	12	100
BT1741C5	4,8	12	100

Polygrip Raka Käftar

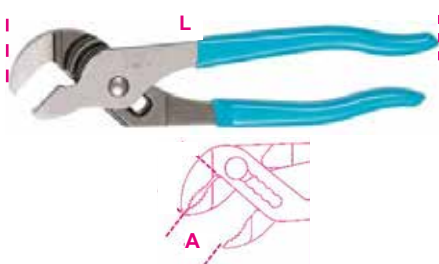

Art.nr.	A max mm	L mm
ML426	22	165

Polygrip Raka Käftar

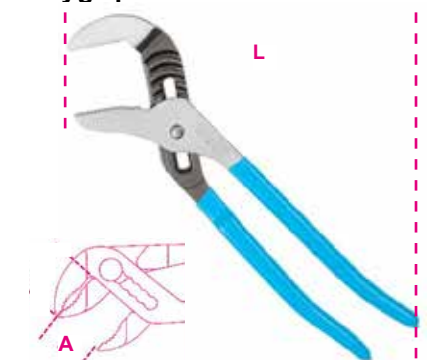

Art.nr.	A max mm	L mm
ML460	108	400
ML480	140	500

Popnittäng



Ø mm	3,2	4,0	4,8	5,0	6,0	6,4
Aluminium	x	x	x	x	x	x
Rostfritt stål	x	x	x	x		

Art.nr.
BT1740A

Polygrip Raka Käftar

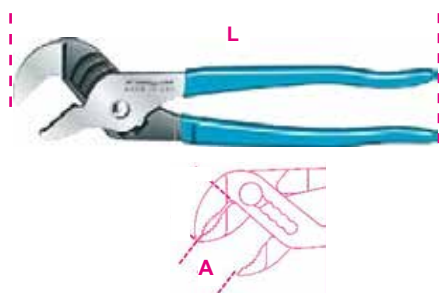

Art.nr.	A max mm	L mm
ML421	38	240

Mutterstång Papegojkäftar

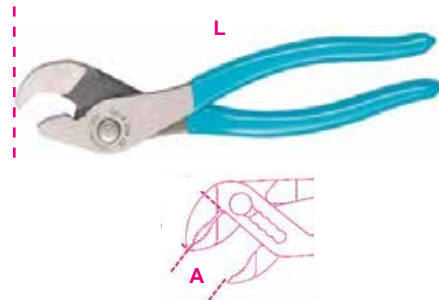

Extremt starka och smidiga käftar.

Art.nr.	A max mm	L mm
ML307	22	175

Popnittäng



Ø mm	3,2	4,0	4,8	5,0	6,0	6,4
Aluminium	x	x	x	x	x	x
Rostfritt stål	x	x	x	x		

Art.nr.
BT1739A

Polygrip V-grepp.

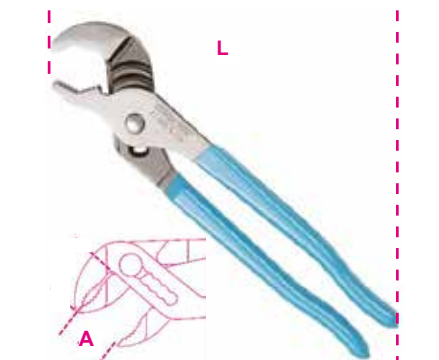

Art.nr.	A max mm	L mm
ML422	38	240

Popnittäng



Ø mm	2,4	3,0	3,2	4,0	4,8
Aluminium	x	x	x	x	x
Stål	x	x	x	x	x
Rostfritt stål	x	x	x	x	

Art.nr.
BT1741

Popnittäng



Ø mm	3,2	4,0	4,8	5,0	6,0	6,4
Aluminium	x	x	x	x	x	x
Rostfritt stål	x	x	x	x	x	x
Inox	x	x	x	x	x	x

Art.nr.
BT1740B330

Popnut Sats



Lämplig för nitar, nitmuttrar och nitskruvar i aluminium, stål och rostfritt stål. 360 ° svängkrans ger kraftigt förbättrad tillgänglighet. Fyra munstycken för standard nitar, fyra dorn för nitmuttrar och tre dorn för nitskruvar. Levereras med skiftnycklar och ett urval av stålningar.

Storlekar: 2.4mm (3 / 32 tum), 3.2mm (1 / 8 tum), 4.0mm (5 / 32 tum), 4.8mm (3 / 16 tum)

Storlekar: M4 x 0,7, M5 x 0,8, M6 x 1
Nitar levereras: M3 x 0,5, M4 x 0,7, M5 x 0,8, M6 x 1 (10 varje storlek)

Art.nr.

JEAK396

Popnut 10st



Art.nr.	Antal	Ø mm
JEAK396021	10	M8x1.25
JEAK396022	10	M10x1.5

Kedjerörtång



Kedjeverktyg för lossning av fastsatta rör och oljefilter.

Art.nr.	Ø max mm	L mm
BT384	115	300

Rörtång Platt käft Vinkel 90°



Art.nr.	Ø max mm	L mm
BT376320	34	320
BT376410	49	410
BT376550	60	550
BT376630	90	630

Kedja



Förlängningskedja till BT384

Art.nr.

BT384RC

Popnut Tång M4-M10



Hejarsmitt ram med patenterad fällmekanism för kompaktlagring. Bekvämt grepp.

Lämplig för gängade nitar upp till M10. Lämplig för aluminium, stål och rostfritt stål, gängade nitar och blindnit.

Storlekar: M4 x 0,7, M5 x 0,8, M6 x 1,0, M8 x 1,25, M10 x 1,5

Längd: 285mm

Art.nr.

JEAK39602

Rörtång Smal käft Vinkel 45°

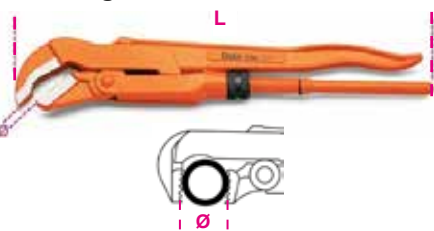

Art.nr.	Ø max mm	L mm
BT374240	21	240
BT374320	34	320
BT374410	49	410
BT374550	60	550
BT374630	90	630

Tång



Verktyget är självlåsande, och käftarna är räfflade med rund spets. Tillverkad i rostfritt stål.

Art.nr.

BT1779

L mm

160

Rörtång Heavy Duty



Art.nr.	Ø max mm	L mm
BT363350	60	350
BT363450	76	450
BT363600	90	600
BT363900	140	900

Sax Heavy duty



Art.nr.

BT1784175

BT1784250

L mm

175

250

Sax



Även designad för att göra hål i plast och kapa och klämma ihop flexrör. Graderad fräsning i metallprofilens ytterkant. Bälteshållare medföljer.

Art.nr.	L1 mm	L mm
BT1128BSX	50	145

Skärblad



Passar BT342

Art.nr.
BT342RL

Slangklammertång 90°



Specialtång med låsning för automatklämmande flata slangklämmor som sitter på nyare bilar.

Art.nr.	Typ	L mm
BV3951S01	45°	275

Slangsax För plastslangar



Art.nr.	Ø mm	L mm
BT341	0 - 25	190

Slangsax 0-50 mm



Art.nr.	Ø mm	L mm
BT342A	0 - 50	270

Slangklammertång 45°



Specialtång med låsning för automatklämmande flata slangklämmor som sitter på nyare bilar.

Art.nr.	Typ	L mm
BV3951S28	90°	275

Skärblad Reservblad

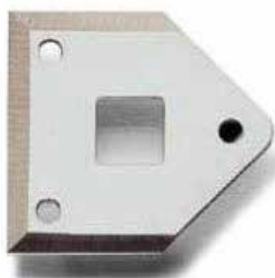

Passar BT341

Art.nr.
BT341RL

Skärblad



Passar BT342

Art.nr.
BT342ARL

Slangklammertång Rak



Specialtång med låsning för automatklämmande flata slangklämmor som sitter på nyare bilar.

Art.nr.	Typ	L mm
BV3951000	Rak	275

Slangsax



Art.nr.	Ø mm	L mm
BT342	0 - 42	200

Slangklammertång



Ger fast grepp om slangar i trånga utrymmen. Tången kan roteras 90 grader för att uppnå den fördelaktiga "Pull vinkeln".

Art.nr.
AST6056

Slangklammertång Flex.



Specialtång med låsning för automatklämmande flata slangklämmor som sitter på nyare bilar.

Art.nr.	L mm
BV3954000	630

Slangklammertång Flex. & Stel



Specialtång med låsning för automatklämma flata slangklämmor som sitter på nyare bilar.
Ställbar

Art.nr. _____ L mm
BV3954100 630

Slangklammertång



Ear-Type Clip Pliers - Extra Heavy-Duty
Each handle features a 1/2" Sq drive for use with a torque wrench and breaker bar where vehicle maker demands specific band tensions. Suitable for all ear-type CVJ boot clips.

Art.nr. _____ L mm
JEVS1639 240

Tångsats Dropstopp



Idealisk sats för att minnimera med spill vid arbete med broms, bränslesystem mm.

Art.nr. _____ Antal
HUAB71100 8

Slangklammertång Till EGT klämma



Art.nr. _____ L mm
BV4199000 630

Bandklammertång Med 3/8"



För montering av nya rostfria band på drivaxlarna.

Art.nr. _____ L mm
JEVS1640 250

Spårrensare Saxprint & Slangavdrag.



För demontering av saxsprint, slangar mm.

Art.nr. _____ L mm
ML1010 190

Reservdelar Till Slangklammertång

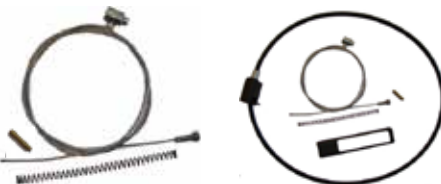

Vajer till:
BV3954000
BV3954100
BV4199000

Komplettsats passar:
BV3954000
BV4199000

Art.nr. _____ Reservdel
BV39540002 Vajer
BV39540001 Komplettsats

Bandtång



Typ: Oetiker

Art.nr. _____ Ø mm L mm
ML7046 0 - 25 245

Slangtving



Art.nr. _____ L x H mm Ø mm
ML2000 45x70 0 - 15
ML2002 60x100 0 - 25

Slangklammertång Bandtång



HEAVY-DUTY CV JOINT BOOT CLAMP PLIERS - EARED TYPE
Install Oetiker-type clamps used on many GM CV joint boots. Heavy-duty pliers feature built-in 1/2" square drives in each arm for use with torque wrench and breaker bar, when high torque is required.
OAL: 11-1/2" (29cm).

Art.nr. _____
CT4210

Klammertång



Typ: Oetiker

Art.nr. _____
BT1473

Slangtång



Med metall quick release system.
Kapacitet 0-25 mm. Längd 200 mm.

Art.nr. _____ Ø mm L mm
ML2001 0 - 25 200

Klämmtång



Verktyg till broms & bränsleslangar.
Mjukt rundade kanter på käken förhindrar skador på slang.
Tillverkad av slitstark glasfiberförstärkt nylon.

Art.nr.	Nr.	Ø mm
JEVS030	1	18
JEVS031	2	36
JEVS032	3	67

Klämmtång



Mycket smidig tång för bromsslangar, bränsleslangar mm

Art.nr.	Ø mm	L mm
ML145	0 - 19	235

Klämmtång



Extremt smidig tång med käftar som går parallellt.

Art.nr.	Ø mm	L mm
ML146	0 - 35	235

Bandklammerverktyg



Max band kapacitet: 1mm tjock x 10mm brett.

Art.nr.
JEVS1636

Slangklammertång Clic



Fjäderbelastad tång för montering och demontering av slangklämmor. Vridbar.

Art.nr.	L mm
JEVS1664	160

Klämmtång



Klarar upp till 3/4" diameter
Funktioner inbyggda Spärrmekanism som låser fast handtag i position.
OL: 10" (55mm)

Art.nr.
CT8800

Klämmtång 0-64mm



Extremt smidig tång med käftar som går parallellt.

Art.nr.	Ø mm	L mm
ML147	0 - 64	235

Slangklammertång Clic



Vridbara käftar för underlättat åtkomsten.
För CLIC and CLIC-R klämmor

Art.nr.	Ø mm	L mm
MU500109	0 - 22	200

Slangtång Självslåsande



Art.nr.	L mm
BT1469	235

Bandklammertång



Stålkäkar med brett handtag för extra komfort. Lämplig för alla öronlösa "typ" CVJ boot klämmor.

Art.nr.	L mm
JEVS1634	235

Slangklammertång Clic



För Clic - slangklämmor

Art.nr.	Ø mm	L mm
ML7043	0 - 17	185

Slangklammertång



Med kraftig låsning för att hålla isär lås klämman.
och justerbara käftar

Art.nr.	Ø mm	L mm
ML7045	0 - 40	215

Slangklammertång



Till självlåsande Mubea FR1 och FR2 klämman. Används på slang i luftladdnings-systemet på VW Golf TDI. Justerbara käftar.

Art.nr.	Ø mm	L mm
ML7055	0 - 35	235

Slangklammertång Flexibel



Till Audi A3, VW Passat från '05, Touran, Golf 5, Passat, 2,0 TDI-motor (Motorkod: BKD)

Art.nr.	Ø mm	L mm
SW60502955		

Slangklammertång



Denna typ av slangklämmor används på Audi och Volkswagens bränslelednings-slangar. Slangklämmorna finns i 2 olika typer. Tången klarar båda sorterna Justerbara käftar, vinklad 40°.

Art.nr.	Ø mm	L mm
ML7052	0 - 49	255

Slangklammertång



Till självlåsande Mubea FR1 och FR2 klämman. Används på slang i luftladdnings-systemet på Audi Q7 & VW Touareg. Justerbara käftar.

Art.nr.	Ø mm	L mm
ML7056	0 - 45	300

Slangklammertång



PSA 1.6l THP och SFW motorer i modell 207 och 308 från '07, Citroen C3, C4 från år '08 och BMW Mini (R55 + R56)

Art.nr.	Ø mm	L mm
SW60503680		280

Slangklammertång Cobra



Till slangklämmor Cobra.
Denna slangklämma används på Opel's luftslangar.

Art.nr.	Ø mm	L mm
ML7053	0 - 30	200

Slangklammertång Audi



För demontering/montering av särskilda klämmor t.ex. Audi A3

Art.nr.	Ø mm	L mm
SW60502900		

Slangklammerverktyg



Perfekt i trånga utrymmen.
Integrerad spärrmekanism som fixerar i varje position. Med anslutning 1/4"

Art.nr.	Ø mm	L mm
MU500015	8 - 70	105

Slangklammertång



Till självlåsande Oetiker-slangklämma.
Denna slangklämma används på flera olika slangar.

Art.nr.	Ø mm	L mm
ML7054	0 - 29	200

Slangklammertång



För självlåsande klämmor på VW Passat från 05 ", Touran, Golf 5, A3, Passat, 2,0 TDI (Motorkod: BKD)

Art.nr.	Ø mm	L mm
SW60502950		295

Slangklammerverktyg VW/Audi



Perfekt i trånga utrymmen. Integrerad spärrmekanism som fixerar i varje position. Gjord speciellt för att klara mycket plana klämmor på VW / Audi. Med anslutning 1/4"

Art.nr.	Ø mm	L mm
MU500016	8 - 70	105

Pincett



Böjd och tunn pincett av rostfritt stål som är PVC-belagd.

Art.nr.	L mm
BT993PL	150

Pincett



Rak och tunn pincett av rostfritt stål som är PVC-belagd.

Art.nr.	L mm
BT994PL	150

Pincett



Fjädrande pincett som är syra och magnetiskt resistent. Stora rundade och räfflade käftar. Rostfrittstål.

Art.nr.	L mm
BT994TF	150

Pincett



Fjädrande pincett som är syra och magnetiskt resistent. Stora rundade och släta käftar. Rostfrittstål.

Art.nr.	L mm
BT999	115

Svetstång



Självläsande tång med dubbel justering och långa käftar.

Art.nr.	L mm
BT1051	255

Svetstång Självläsande, konkava käftar

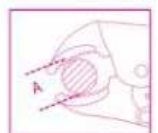

Art.nr.	A max mm	L mm
BT1052140	22	140
BT1052190	36	190
BT1052240	42	240
BT1052300	55	300

Svetstång

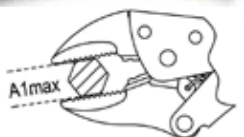

Självläsande tång med justering och rörliga käftar.

Art.nr.	A1 max mm	L mm
BT1053G	35	240

Svetstång

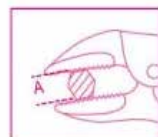

Självläsande tång med justering och raka käftar.

Art.nr.	A max mm	L mm
BT1054	40	235

Svetstång

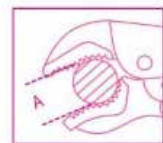

Självläsande tång med justering och krökta käftar.

Art.nr.	A max mm	L mm
BT1055	60	250

Svetstång Självläsande, långa käftar



Art.nr.	S max mm	A max mm	L mm
BT1058180	/	38	180
BT1058240	100	65	240
BT1058310	150	80	310

Svetstång Självläsande, gaffel käftar

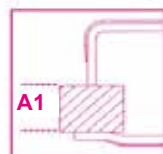

Art.nr.	A1 max mm	L mm
BT1060200	50	200
BT1060280	80	280

Svetstång Självläsande, gaffel käftar



Art.nr.	A1 max mm	L mm
BT1061	80	290



Svetstång

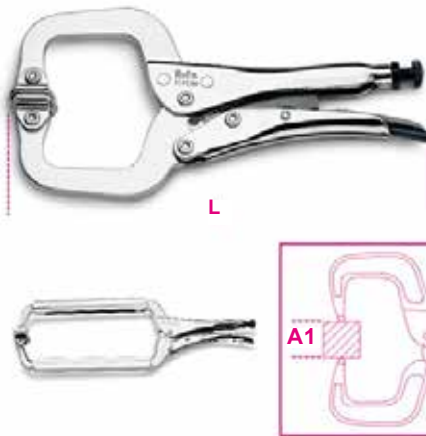

Svetstångsats 5 verktyg



Kompakt storlek med tryckknapp för käken. Idealisk i trånga utrymmen. Hanteras med en hand.

Art.nr.	Nr.	Ø max mm	L mm
JEA68402	1	0-18	195
	2	0-15	205
	3	0-15	210
	4	0-15	195
	5	0-15	230

Svetstång

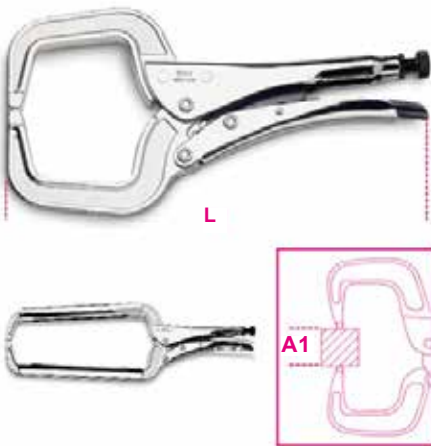

Självlåsande tång med justering och C-formade och rörliga käftar.

Art.nr.	A1 max mm	L mm
BT1062GM170	45	170
BT1062GM290	88	290
BT1062GM460	260	460

Muttertång Glödstift Special

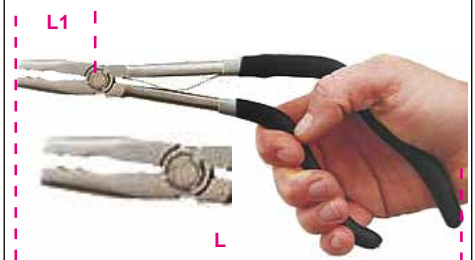

Art.nr.	L1 mm	L mm
MU748320	80	300

Självlåsande tång med justering och C-formade käftar.

Art.nr.	A max mm	L mm
BT1062170	50	170
BT1062290	120	290
BT1062460	250	460

Svetstång

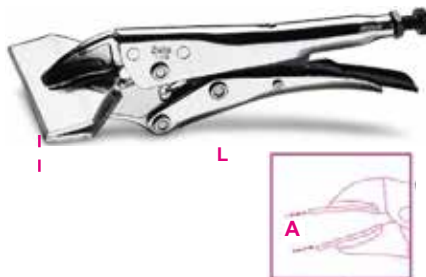

Självlåsande tång med justering och breda platta käftar.

Art.nr.	A max mm	L mm
BT1063	30	200

Glödstiftstång Rak



För rätt demontering av anslutningskontakten till glödstift.

Art.nr.	L mm
AST6071	235

Kedjetång



Självlåsande tång med justering och kedja.

Art.nr.	Ø max mm	L mm
BT1064	150	240

Glödstiftstång Böjd



För rätt demontering av anslutningskontakten till glödstift.

Art.nr.	L mm
AST6072	245

Tändhattstång

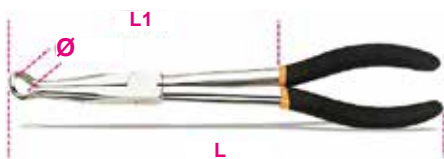

Art.nr.	Ø mm	L1 mm	L mm
BT1474DL	12	170	275

Tändhattstångsats

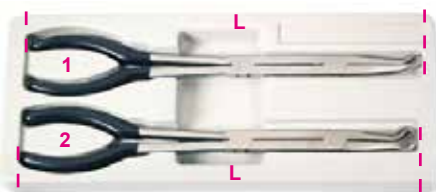

Art.nr.	Nr.	Ø mm	L mm
MU7482002	1	6	325
	2	12	320

Verktygsats Skruvmejsel 7st

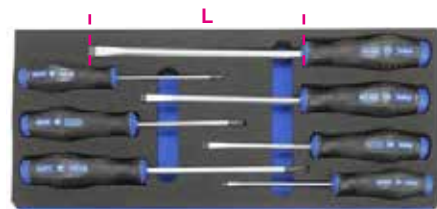

Art.nr.	Typ	Ø mm	L mm
SRBX005A	●	9,5	200
	●	8	150
	●	6	100
	●	4	100
	⊕	PH1	150
	⊕	PH2	100
	⊕	PH3	150

Tändhattstång



Med långa käftar för demontering av tändhattar, utan att förstöra tändhattarna.

Art.nr.	L mm
E465300	300

Tändhattstång 6mm



Art.nr.	Ø mm	L mm
MU748204	6	325

Verktygsats Skruvmejsel 8st

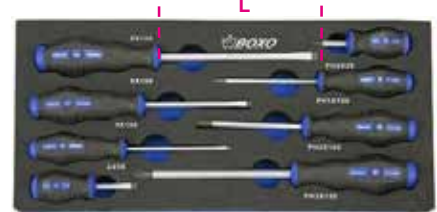

Art.nr.	Typ	Ø mm	L mm
SRBX040	●	4	100
	●	6	38
	●	6	100
	●	8	150
	⊕	PH1	100
	⊕	PH2	38
	⊕	PH2	100
	⊕	PH3	150

Tändhattstång



För demontering av tändkablar utan att förstöra.

Art.nr.	L mm
MLOPK21	195

Tändhattstång 12mm



Art.nr.	Ø mm	L mm
MU748205	12	320

Verktygsats Skruvmejsel Torx 7st

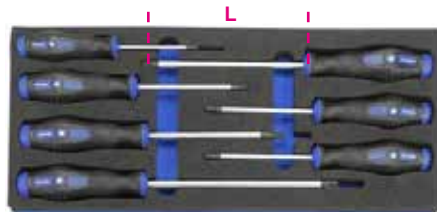

Art.nr.	Typ	Ø mm	L mm
SRBX005TA	⊗	T20	75
	⊗	T25	100
	⊗	T27	100
	⊗	T30	100
	⊗	T40	125
	⊗	T45	150
	⊗	T50	175

Tändhattstång



Med långa käftar för demontering av tändkablar utan att förstöra tändkablar.

Art.nr.	L mm
MLOPK22	240

Verktygsats Skruvmejsel 8st

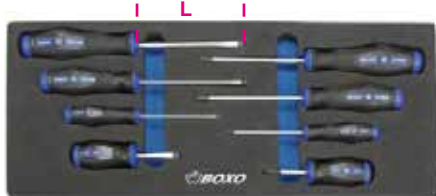

Art.nr.	Typ	Ø mm	L mm
SRBX004A	●	8	150
	●	6	100
	●	4	100
	●	6	38
	⊕	PH3	150
	⊕	PH2	100
	⊕	PH1	100
	⊕	PH2	38

Verktygsats Genomgående klinga 7st



Art.nr.	Typ	Ø mm	L mm
SRBX005	●	5	100
	●	6	100
	●	8	150
	●	9,5	200
	⊕	PH1	100
	⊕	PH2	100
	⊕	PH3	150

Verktygsats T-handtag Insex 8st



Art.nr.	Typ	Ø mm
SRBX020	○	H2
	○	H2,5
	○	H3
	○	H4
	○	H5
	○	H6
	○	H8
	○	H10

Verktygsats 39st



Verktyg Anslut. Typ Ø mm

Hylsa	1/4"	⊗	E4, E5, E6, E7, E8, E10
Hylsa	1/2"	⊗	E11, E12, E14, E16, E18, E20, E22, E24
Hylstapp		⊗	T10, T15, T20, T25, T27, T30, T40, T45, T50, T55, T60, T70
Ringspärnyckel		⊗	E6*E8, E10*E12, E14*E18, E20*E24
Vinkelnnyckel		⊗	T10, T15, T20, T25, T27, T30, T40, T45, T50

Art.nr.

SRBX033

Verktygsats



SRBX041

Verktygsats T-handtag Torx 9st

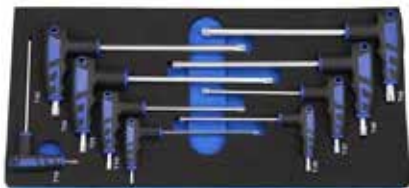

Art.nr.	Typ	Ø mm
SRBX021	⊕	T10
	⊕	T15
	⊕	T20
	⊕	T25
	⊕	T27
	⊕	T30
	⊕	T40
	⊕	T45
	⊕	T50

Verktygsats



SRBX042

Verktygsats Skruvmejsel & Tång Mini

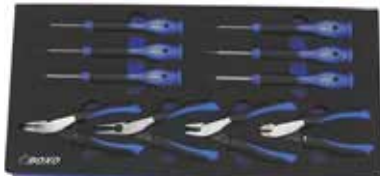

Art.nr.	Typ	Ø mm	L mm
SRBX012	⊕	PH00	
	⊕	PH0	
	⊕	PH1	
	●	1,5	50
	●	2,0	50
	●	3,0	50
		Kombinationstång	125
		Tång med lång käft	125
		Avbitartång	115
		Vinklad 45°	125

Verktygsats 17st



Typ Ø mm

Blocknyckel	8, 9, 10, 11, 12, 13, 14, 15, 16, 17, 18, 19
Måttband	5 m

Art.nr.

SRBX045

Verktygsats Lednycklar



SRBX019

Verktygsats



SRBX006

Verktygsats



SRBX011

Verktysats



SRBX009

Verktysats



SRBX034

Verktysats



SRBX014

Verktysats



SRBX025

Verktysats



SRBX026

Verktysats



SRBX047

Verktysats



SRBX028

Verktysats



SRBX026

Verktysats



SRBX073

Verktysats



SRBX010

Verktysats



SRBX013

Verktysats



SRBX031

Verktygsats



SRBX037

Verktygsats



SRBX017

Verktygsats



SRBX032

Verktygsats



SRBX002A

Verktygsats



SRBX029

Verktygsats



SRBX022A

Verktygsats



SRBX038

Verktygsats



SRBX015A



Verktygsats



SRBX016

Verktygsats

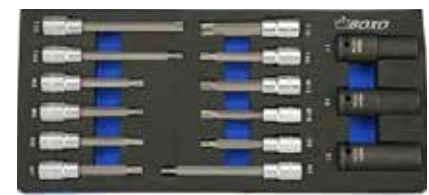

SRBX039

Avdragare

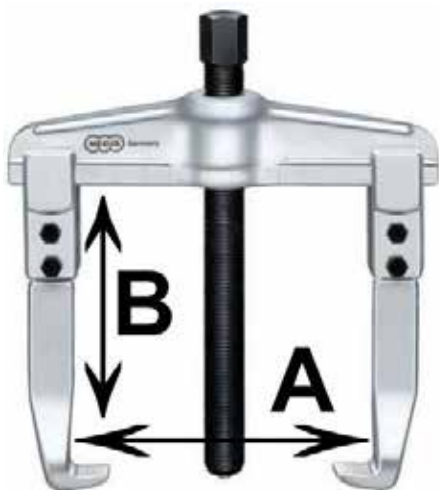

Art.nr.	Amm	Bmm
NE1001	25-80	100
NE10015	25-130	100
NE1002	50-160	150
NE10025	60-200	150
NE1003	80-250	200
NE10035	80-350	200
NE1004	110-520	200
NE1005	170-640	225

Avdragare

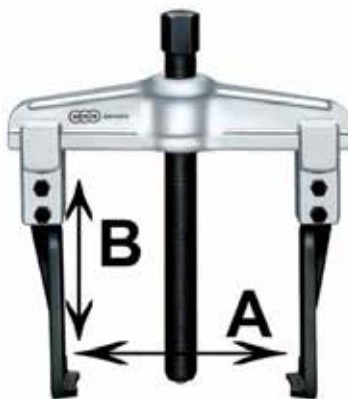

Avdragare

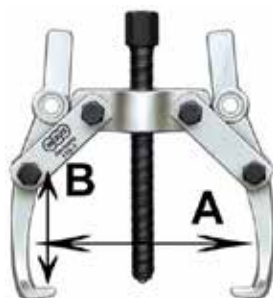

Art.nr.	Amm	Bmm
NE1151	20-170	130
NE1152	20-230	200

Avdragare



Art.nr.	Amm	Bmm
NE140	10-50	40

Avdragare

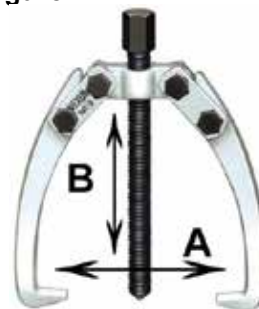

Art.nr.	Amm	Bmm
NE1411	10-60	40
NE1412	10-70	44-74
NE1413	10-90	44-84

Avdragararmar

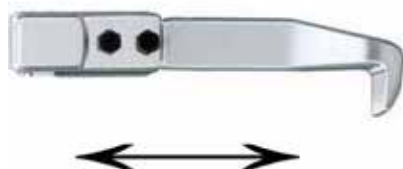

Avdragararm 1 par
Längden på armarna anges utav sista siffrorna, ex: NE-2-300 är 300mm långa

Artikel	Passar avdragare
NE190	NE1001 - NE10015
NE1120	
NE1200	
NE1250	
NE2150	NE1002 - NE10025
NE2220	
NE2300	
NE3200	NE1003 - N10035 - NE1004
NE3300	
NE3400	
NE3500	
NE5225	NE1005
NE5300	
NE5400	
NE5500	

Avdragare



Art.nr.	Amm	Bmm
NE1191	100	170
NE1192	150	270
NE1192	150	330

Avdragare



Art.nr.	mm
NE3141	6-100
NE3142	10-140
NE3143	15-140

Avdragare



Art.nr.	Amm	Bmm
NE131	20-150	85
NE132	40-220	130

Avdragare 3-Armad



Art.nr.	Amm	Bmm
NE133	20-150	85

Avdragare 3-Armad



Art.nr.	Amm	Bmm
NE133	20-150	85
NE134	40-220	130

Kulledsavdragare



Universal

Art.nr.	A/B
NE-166-1	18/330mm
NE-169-2	23/330mm
NE-166-3	31/330mm
NE-166-4	35/350mm
NE-166-5	45/350mm

Kulledsverktyg



A 24mm
B 45mm
MU6091014

Avdragare



Art.nr.	Amm	Bmm
NE14110	10-60	40
NE14120	10-40	44/74

Kulledsavdragare

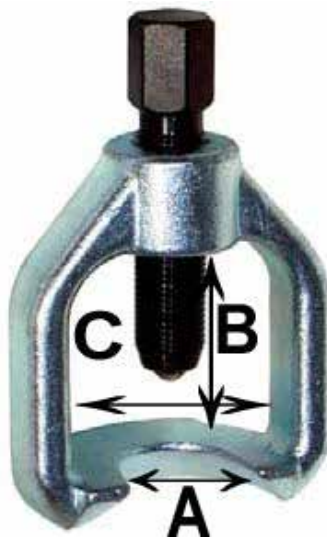

Universal

Art.nr.	A/B/C
NE1671	18/40/40mm
NE1672	25/50/50mm
NE1673	29/60/60mm
NE1674	40/80/80mm
NE1675	45/100/90mm

Kulledsavdragare



A 24mm
B max 50mm

NE1691

Avdragare 3-Armad

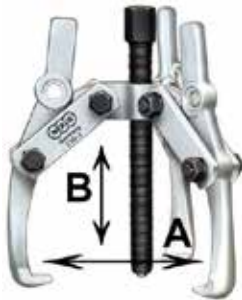

Art.nr.	Amm	Bmm
NE1161	20-170	130
NE1162	20-230	200

Kulledsavdragare

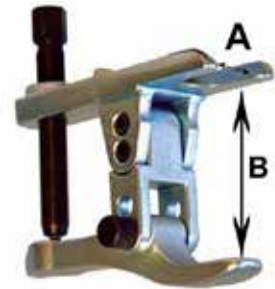

A 24mm
B 60-80mm

NE1692

Avdragare

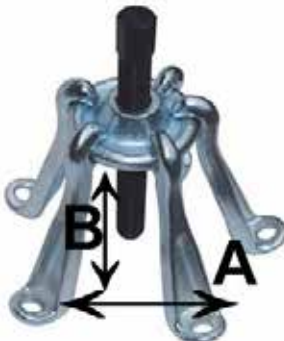

Art.nr.	Maxd.	Armar
NE1503	225mm	3
NE1505	225	5

Kulledsavdragare

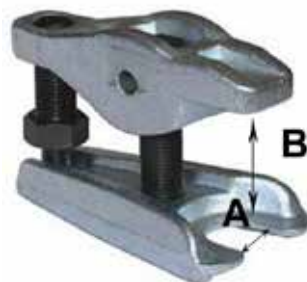

A 18/22mm
B max 50mm

NE1681

Kulledsavdragare



Art.nr.	A	B max
NE1694	36mm	90mm
NE1695	45 mm	115 mm

Lageravdragare



lager:
1547 / 1
6004-6010, 6200-6205, 6300-6304
1547 / 2
6011-6014, 6206-6211, 6303-6308, 6403-6405

BT1547C6

Rattavdragare



Rattavdragare med korta och långa armar samt en kopp för spindeln
A max 90mm B 135mm

NE18540

Rattavdragare



Universiell rattavdragare
bolts. 5/16" - 18, 5/16" - 24,
3/8" - 16, 1/4" - 28 & 8mm - 1.25,

CT1515

Lageravdragare



NE510A

A 5-7mm B 30mm

NE510B

A 7-9mm B 30mm

NE510C

A 9-12mm B 30mm

NE511A

A 10-13mm B 30mm

NE511B

A 13-17mm B 50mm

NE512A

A 14-19mm B 60mm

NE512B

A 16-21mm B 60mm

NE513A

A 20-25mm B 60mm

NE513B

A 22-27mm B 60mm

NE514A

A 25-30mm B 60mm

NE515A

A 30-37mm B 70mm

NE516A

A 38-45mm B 70mm

NE517A

A 45-55mm B 100mm

NE517B

A 50-60mm B 100mm

NE51E7

A 40-75mm B 100mm

NE51E8

A 70-115mm B 130mm

Lageravdragare



Slagurdragare för centrumlager 13-38 mm

CT8077

Torkararmsavdragare



Specialavdragare för torkararmar

NE142S

Lageravdragare



Urdragare för centrumlager 13-38 mm

CT8070

Svånghjulsavdragare



Universal

CT2236

Slaghammare



Slaghammare M10
passar urdragare:

NE510A
NE510B
NE510C
NE511A
NE511B
NE512A
NE512B

NE5201

Slaghammare



Slaghammare M10
passar urdragare:

NE513A
NE513B
NE514A
NE515A
NE516A

NE5202

Urdragare



Art.nr.	Passar	Gänga
NE521	NE510A-516B	M10
NE522	NE517A-517B	3/8 R

Urdragare



Art.nr.	Passar	Gänga
NE521A	NE510A-516B	M10
NE5215	NE514B-517B	3/8 R

Lageravdragare



Avdragaren levereras utan ben

NE601
kg 0,3

NE602
kg 0,4

NE603
kg 0,5

NE604
kg 0,9

NE605
kg 1,2

Bensatser till NE60

mätten anger längden

Avdragarben 4st per fp till NE601
NE611 120mm 0,1kg

NE612 120mm 0,1kg

Avdragarben 4st per fp till NE602

NE613 130mm 0,2kg

NE614 130mm 0,2kg

NE615 150mm 0,3kg

Avdragarben 4st per fp till NE603

NE614 130mm 0,2kg

NE615 150mm 0,3kg

NE616 150mm 0,4kg

Avdragarben 4st per fp till NE604

NE615 150mm 0,3kg

NE617 190mm 0,6kg

Avdragarben 4st per fp till NE605

NE615 150mm 0,3kg

NE616 150mm 0,4kg

NE618 190mm 0,8kg

Avdragarplattor

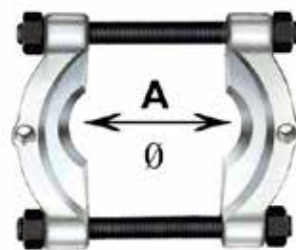

Avdragarplatta

NE-1700

A 5-60mm
för avdragare NE1720, NE1721

NE1701

A 12-75mm
för avdragare NE1721

NE1702

A 22-115mm
för avdragare NE1722

NE1703

A 25-155mm
för avdragare NE1723

NE1704

A 30-220mm
för avdragare NE1724

NE1705

A 40-280mm
för avdragare NE1725

Avdragarrok

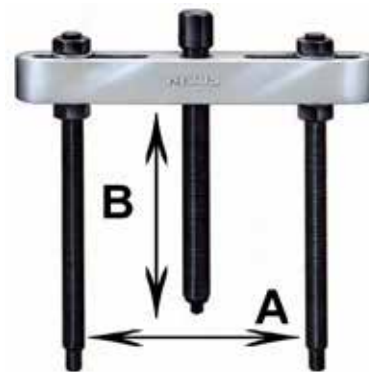

Avdragare passar (Platta NE170)

NE1720

A 40-115mm B 150mm

NE1721

A 45-140mm B 150mm

NE1722

A 55-205mm B 210mm

NE1723

A 90-260mm B 315mm

NE1724

A 100-360mm B 305mm

NE1725

A 140-435mm B 320mm